



12x8 Cabana - Bevel Metal Roof Assembly Manual

Version #1.9
January 18, 2022

Thank you for purchasing a 12x8 Cabana. Please take the time to identify all the parts prior to assembly.

STOCK CODE #
CB128-AK-METAL



Safety Points and Other Considerations
Our products are built for use based on proper installation on level ground and normal residential use. Please follow the instruction manual when building your shed and retain the manual for future maintenance purposes.

Customers are responsible for ensuring a solid, level, well-draining site for construction.

Please check with your local municipal or county by-laws before ordering this product to confirm it complies with building codes.

- Snow load ratings vary by geographical location. If heavy or wet snowfall occurs, it is advisable to sweep snow off roof frequently.
- If the product is elevated, any structural and building code requirements are solely the customer's responsibility, and should be abided by.
- In areas with high or gusty wind conditions, it is advisable to install the structure securely to the ground.
- Have a regular maintenance plan to ensure screws, doors, windows and parts are tightly affixed.



Customer agrees to hold Outdoor Living Today and any Authorized Dealers free of any liability for improper installation, maintenance and repair.

In the event of a missing or broken piece, call the Outdoor Living Today Customer Support Line @ 1-888-658-1658 within 30 days of the delivery of your purchase. It is our commitment to you to courier replacement parts, free of charge, within 10 business days of this notification. Replacement parts will not be provided free of charge after the 30 day grace period.

All structures purchased from Outdoor Living Today are covered for a period of one year for defects in manufacturing and workmanship. Costs incurred for customer installations are not included.

Failure to use supplied parts included in this kit could result in poor product performance and may void your warranty. Please contact Outdoor Living Today's Customer Toll Free Line if you plan to deviate from our written instructions.

What to do before my Shed arrives?



- Become familiar with this assembly manual and determine if you can complete the project yourself or will require a professional contractor.



- One helper is recommended to assist in constructing your shed. It generally takes two people over two days to assemble a shed. If you're hiring a contractor, their rate should be in line with that duration of work.



- Clear the construction area and ensure a clear pathway for delivery when the freight company arrives. Remove all debris: roots, grass, rocks, etc.



- Excavate the site. Contact your local utilities company to ensure there are no gas or electric lines buried in the area before digging.

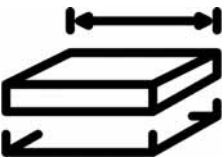

- Decide on the type of foundation you will be using:
 - Concrete slab, or
 - 4-6 inches of crushed gravel with paver stones or 4x4 stringers.

You can find the footprint for your shed on Page 3 of your Assembly Manual.

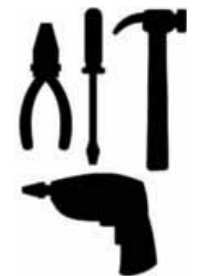

- If doing the assembly yourself, have all the necessary tools ready to go and in working condition. A list of required tools can be found after the parts list.

Foundation Types for 8x12 Garden Shed

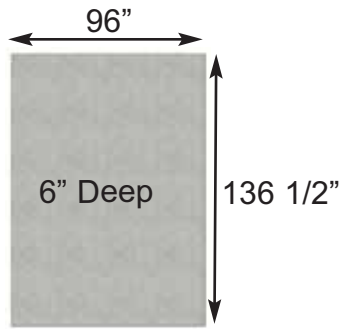

Concrete Foundation

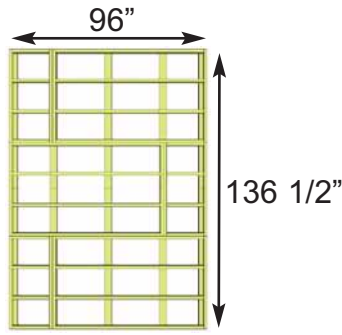

Floor Frame



Completed Foundation

Concrete Slab Foundation:

- Slab must be at least the same size as assembled floor frame (136 1/2" x 96") or larger.
- 6" Deep foundation.
- 1.7 Cubic Yards of concrete required.
- A concrete slab will have the longest durability out of your foundation options.

Once level, a concrete slab is the easiest surface to build on.

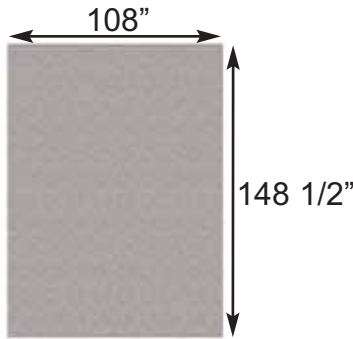

Gravel Foundation

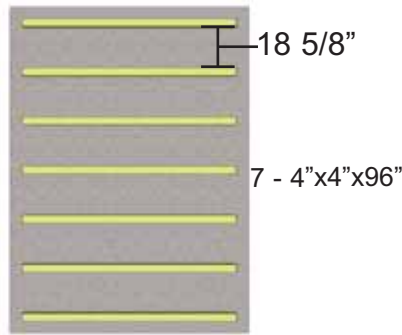

Gravel Foundation with treated stringers

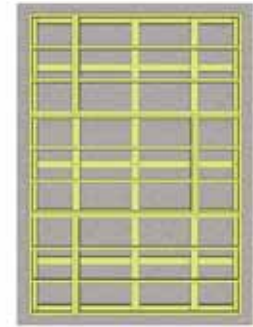

Completed Foundation

Gravel with 4x4 Pressure Treated Stringers:

- Excavate at least 6" deep, and 6" wider than floor frame on each side.
- 2.1 Cubic Yards of gravel required, approximately 19 wheelbarrows.
- 7 - 4x4 Pressure Treated Stringers 8' long required.
- Evenly spaced, with one at each end of floor frame.

Saves money on materials, easy to level and work with.

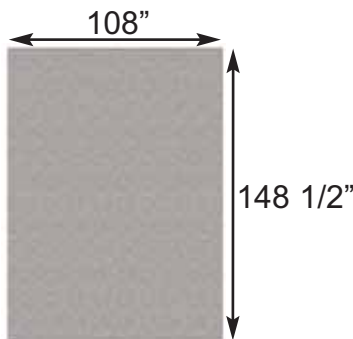

Gravel Foundation



Gravel Foundation with Patio Pavers

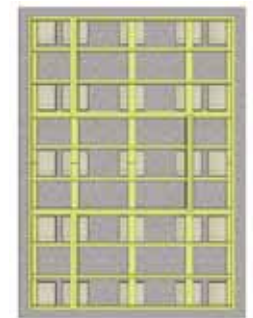

Completed Foundation

Gravel with Patio Paver Stones:

- Excavate at least 6" deep, and 6" wider than floor frame on each side.
- 2.1 Cubic Yards of gravel required, approximately 19 wheelbarrows.
- 25 patio pavers (8" x 8" or larger).
- Center patio paver stones underneath floor runners and underneath seams in floor joists.

Patio paver stones are widely available from most landscape stores.

**Thank you for purchasing our 12x8 Cabana Garden Shed.
Please take the time to identify all the parts prior to assembly.**

1. Floor Section	Parts List - Pages 2 and 3	Steps ↓
Floors ----- 3 - 45 1/2" x 75" - Floor Joist Frames - Large 3 - 45 1/2" x 21" - Floor Joist Frames - Small 6 - 1 1/2" x 3 1/2" x 71 7/8" - Center Floor Joists - Unattached 10 - 1 1/2" x 3 1/2" x 68 3/16" - Floor Runners 3 - 45 3/8" x 74 7/8" - Plywood Floor - Large 3 - 45 3/8" x 20 7/8" - Plywood Floor - Small		1-12
2. Wall Section Main Wall Panels ----- 7 - 45 1/2" x 75" - Solid Wall Panels 7 - 1 1/2" x 2 1/2" x 45 1/2" - Bottom Wall Plates 2 - 45 1/2" x 75" - Window Wall Panels 1 - 12" x 73" - Narrow Wall Panel Door Header & Jamb ----- 1 - 1 1/2" x 3 1/2" x 73" - Vertical Door Jamb 1 - 2" x 3 1/2" x 45 1/2" - Door Header (Dado cut on edge) Top Wall Plates & Gables ----- 6 - 3/4" x 2 1/2" x 32" - Side Top Plates (4 pieces angle cut on end, 2 piece straight cut both ends) 4 - 3/4" x 2 1/2" x 65 3/4" - Front & Rear Top Plates (angle cut edge) 4 - Gable Half Walls - Triangular Shaped		Steps ↓ 13-20 21-22 24-27
3. Rafter and Roof Section Rafter Assembly ----- 2 - 3/4" x 4 1/2" x 84" - Roof Ridge Boards 2 - 3/4" x 4 1/2" x 52 1/2" - Roof Ridge Boards 18 - 1 1/2" x 3 1/2" x 56 1/2" - Roof Rafters 4 - 1/2" x 4 1/2" x 68 1/4" - Soffits 3 - 3/4" x 3 1/2" x 72" - Roof Gussets (angle cut on ends) Roof ----- 16 - 3/4" x 3 1/2" x 49 1/4" Roof Batten (outside) 8 - 3/4" x 3 1/2" x 45 1/2" Roof Batten (middle) 12 - 3/4" x 1 1/2" x 14 1/8" - Batten Spacers 8 - 61" long x 39" wide Metal Roof Panels 3 - 13"w x 60" Metal Ridge Cap Several Strips of Foam Enclosures for Metal Roof Ends		Steps ↓ 28-38 39-55
4. Trim & Miscellaneous Section Outer Wall Trim ----- 10 - 3/4" x 4 1/2" x 45 1/4" - Bottom Skirting (Bevel) 4 - 7/8" x 2 1/2" x 75" - Filler Trim 5 - 3/4" x 1 1/2" x 45 1/4" - Top Wall Trim (Bevel) 4 - 3/4" x 4 1/2" x 45 1/4" - Horizontal Gable Trim (Bevel) 4 - 1/2" x 3 1/2" x 79" - Corner Trim 4 - 1/2" x 5 1/2" x 82" - Wide Corner Trim 2 - 1/2" x 2 1/2" x 79" - Rear Wall Narrow Trim 2 - 1/2" x 2 1/2" x 77 1/2" - Side Wall Narrow Trim Facia Trim ----- 4 - 3/4" x 2 1/2" x 51" - Facia Nailing Strips 4 - 3/4" x 3 1/2" x 58" - Side Facia (Angle Cut, 2 right, 2 left) 4 - 3/4" x 3 1/2" x 71 3/4" - Front and Rear Facia 2 - Pentagon Facia Plate - For Side Facia Peaks 2 - Horizontal Gable Trim Detail Plates - 4 1/2" high 2 - Facia Detail Plates - 3 1/2" high		Steps ↓ 56-62 63-67

Continued on next page

Note: All Trim, Facia and Bottom Skirting pieces will be positioned rough face out when installed.

Door Section

- 2 - 1/2" x 3 1/2" x 79" - Vertical Door Trim
- 1 - 1/2" x 2 1/2" x 79" - Front Wall Narrow Trim
- 1 - 1/2" x 1 1/4" x 32" - Horizontal Door Trim
- 1 - 1/2" x 1 1/4" x 7" - Horizontal Narrow Wall Trim
- 1 - 31 1/2" x 30" - Top Dutch Door Section
- 1 - 31 1/2" x 42" - Bottom Dutch Door Section
- 2 - 1/2" x 2 1/2" x 72" - Interior Vertical Door Stops
- 1 - 1/2" x 2 1/2" x 36" - Interior Top Horizontal Door Stop

Miscellaneous

- 2 - Metal Window Inserts
- 2 - Window Trim Pkgs - (1 - 24 1/16" angle cut / 3 - 23" square cut)
- 2 - Flower Box Kits
- 1 - Spare Wall Siding
- 2 - Spare Shingles - use to shim door, etc

















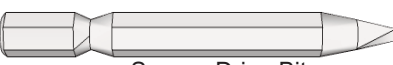

Steps

68-75

76-79

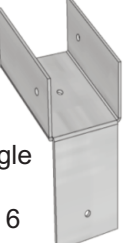
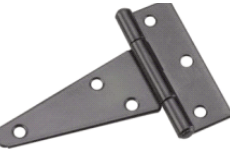
12 x 8 CABANA WITH METAL ROOF HARDWARE SHEET

Hardware Kit (Provided)

S1 - 2 1/2"  310 Pcs	S2 - 1 1/4"  210 Pcs
S3 - 2"  155 Pcs	SS2 - 3/4"  25 Pcs Silver
SB2 - 2"  28 Pcs Black Headed	SB1 - 3/4"  10 Pcs Black Headed
3/8"x 2"  x 53 Metal Roof Screw	N1 - 1 1/2"  365 Pcs Finishing
Y3 - Black Handle 	N2 - 1 1/2"  60 Pcs Shingle
Silicon Caulking (2) 	BR1  2 Pcs Square Drive Bit
Y4 - Black Drop Latch 	 1/4" Nut Driver
Y38 - Metal Roof Hanger x 4 	Y30 - Single Rafter Bracket x 6 
Y1 - Tee Hinge x4 	Y31 - Double Rafter Bracket x 4 
Y5 - Interior Silver Barrel Bolt 	
Y9 - Ridge Board Connector x 2 	

Tools Required (Not Provided)

 Hammer	 Screw Gun/Drill	 Tape Measure
 Level	 Pliers	 Ladder
	 Wood Clamp	 1/8" Drill Bit

Safety Equipment Required (Not Provided)

 Safety Glasses
 Work Gloves

Before/During Assembly:

- 1.) Paint each face and edge of your plywood floor with a latex exterior paint.
- 2.) Caulk wall seams if gaps appear.
- 3.) Caulk around window framing.
- 4.) Caulk perimeter between floor plywood and bottom wall plate.
- 5.) Caulk channels in lap siding at the top of your door above the trim, just a drop in each channel.
- 6.) Caulk edge of door threshold (if applicable).
- 7.) Optional: Install a Sill Gasket between floor runners and foundation.
- 8.) Optional: Install an 8" strip of roofing paper below Cedar Ridge Caps for Cedar Roof Sheds.

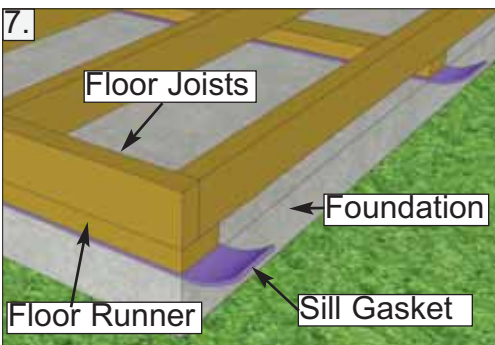
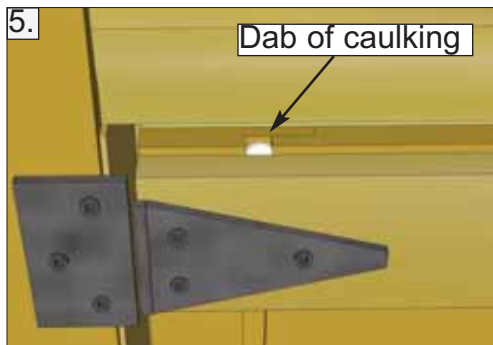
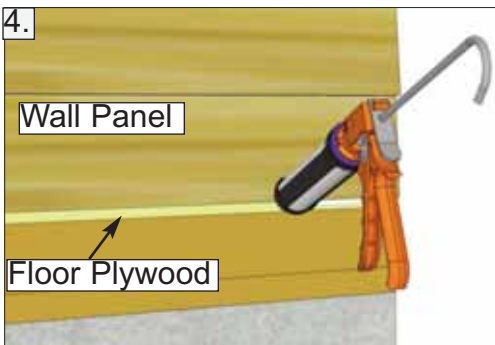
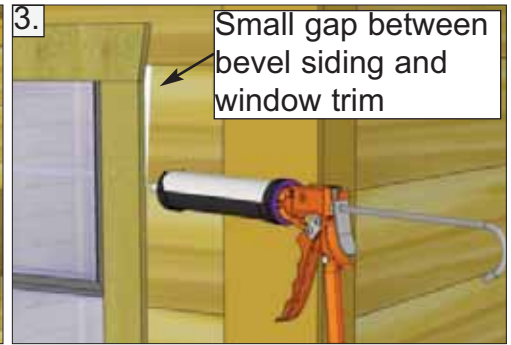
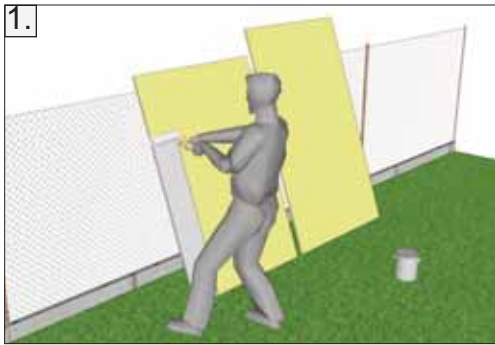

Routine Maintenance:

- Routinely check all fasteners are tight (ex. Door Hinges, Nails)
- Brush off dirt from walls.
- Brush off snow from roof regularly.
- Routinely remove needles and leaves from roof.

Painting/Staining

- Your cedar shed, if left untreated, will weather to a silvery grey colour.
- Painting or staining your structure is highly recommended and will prolong the life of your shed.
- You do not need to wait to paint or stain your shed, the wood in your kit has been dried and can be stained or painted immediately.
- Consult your local paint store for the best paint or stain for cedar.
- Optional: stain the inside of your shed. (Note: this will remove the fresh cedar smell.)

A. Floor Section

Exploded view of all parts necessary to complete Floor Section. Identify all parts prior to starting. Note: Floor Footprint is 136 1/2" wide x 96" deep.

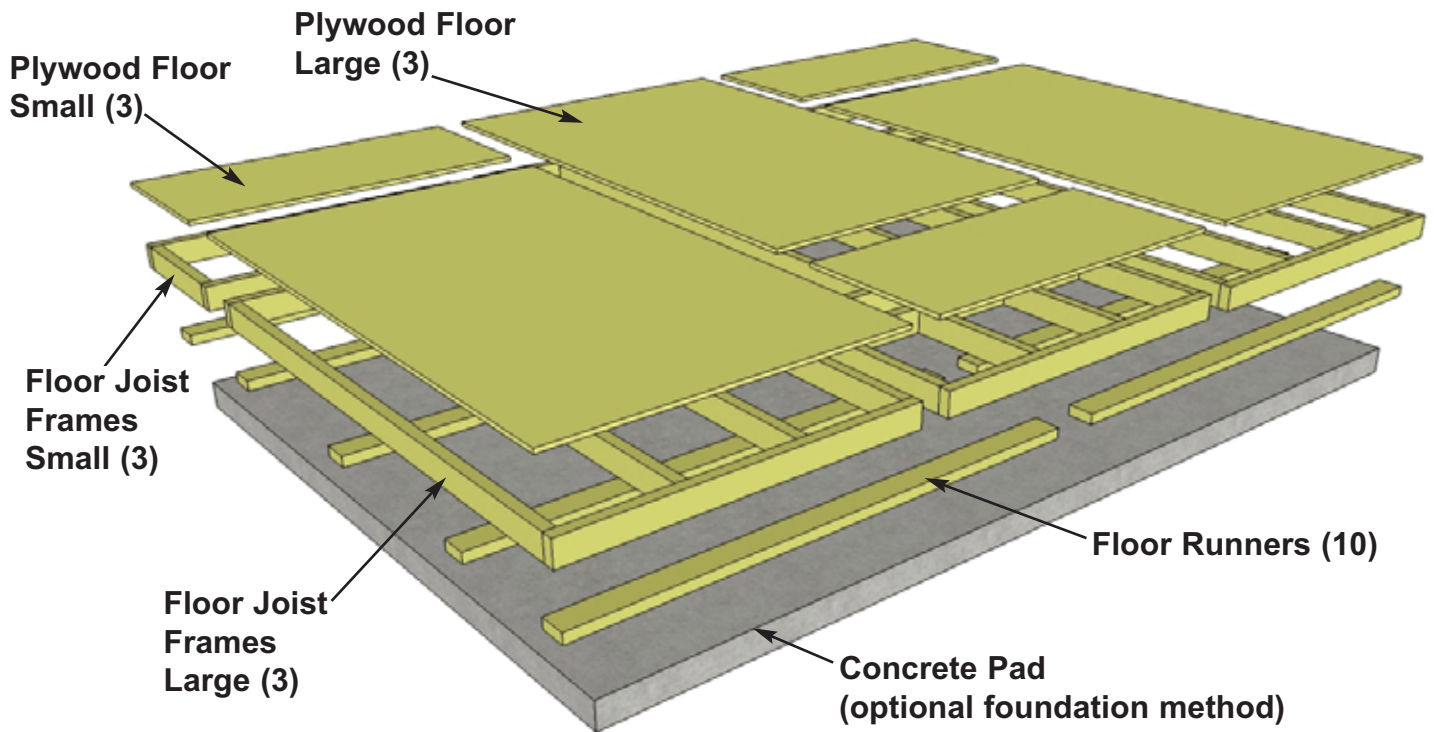

Flush with framing



1. Lay out **Large Floor Joist Frame** and **2 Floor Joists** as illustrated above. Position Joists equally in Floor Joist Frame. Use **Small Floor Joist Frame** as a template to determine joist position. Position Joist so flush with framing.

Parts (Steps 1 - 6)

Floor Joists

(1 1/2" x 3 1/2" x 71 7/8") x 6

Floor Joist Frames - Large

(45 1/2" x 75") x 3

Floor Joist Frames - Small

(45 1/2" x 21") x 3

Hardware (Steps 1 - 6)

S1 - 2 1/2" Screws

x 58 total

You can find the Square Drive Bit for the screws in with the Hardware Kit Bag.

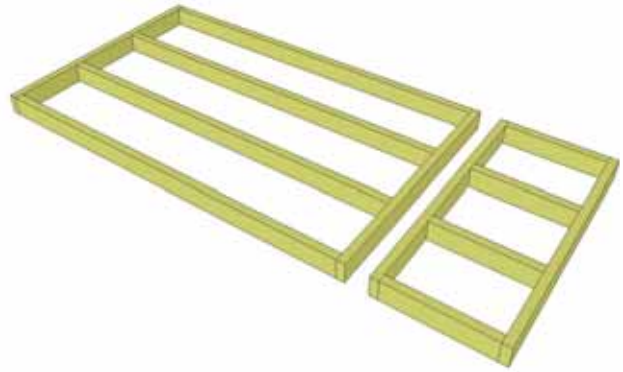
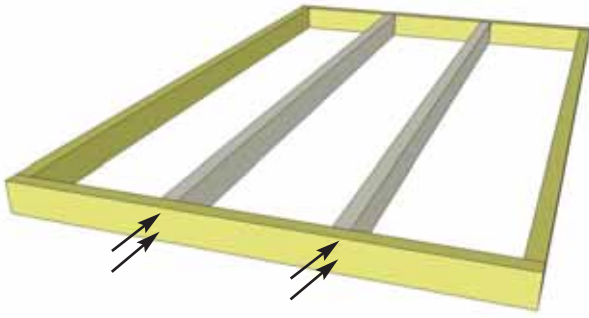

2. When correctly positioned, attach each Joist with 4 - 2 1/2" screws (2 per end). **You can find the Square Drive Screw Bit in the Hardware Kit Bag.**

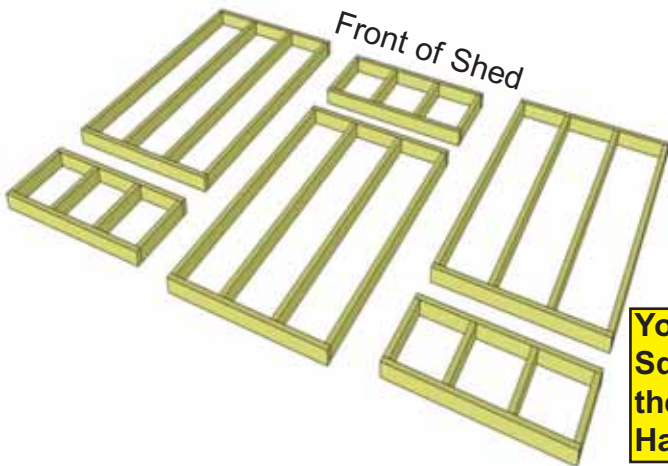

You can find the Square Drive Bit for the screws in with the Hardware Kit Bag.

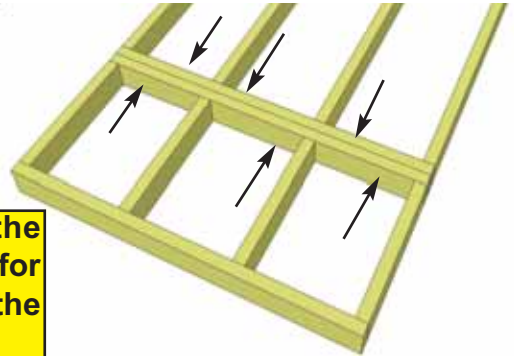

3. Lay out **Floor Joist Frames** as illustrated. There are 3 larger and 3 smaller Frame Sections. The Footprint for the floor when attached together will be 136 1/2" wide x 96" deep.

4. Attach each large and small floor joist frame together with **6 - 2 1/2" Screws** per section.

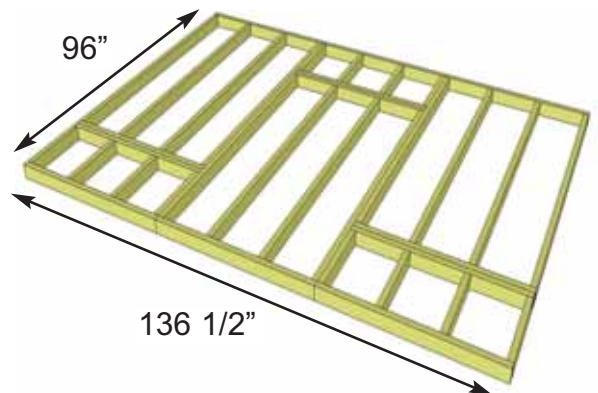

5. Complete all large and small frame attachments. Screw each completed section together with **8 - 2 1/2" Screws**.

6. When completed, your floor footprint should be 136 1/2" wide x 96" deep.

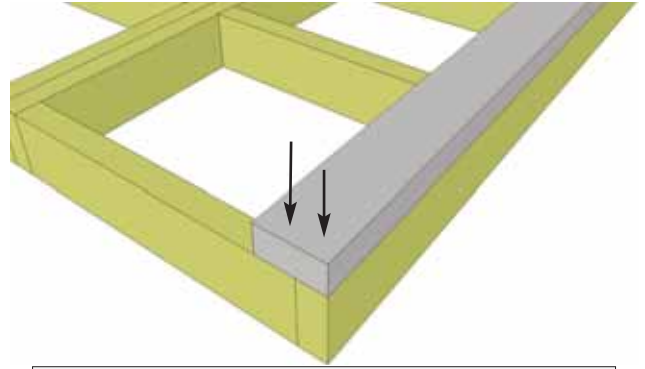
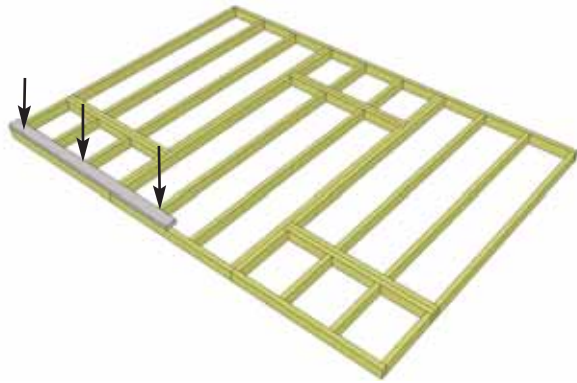

7. Attach **Floor Runners** to completed floor frame. There are 2 Floor Runners per 136 1/2" side and 5 completed Runners in total. Use **6 - 2 1/2" Screws** per Runner.

8. Make sure Runners are flush with outside and front and rear floor framing but not overhanging.

<u>Parts (Steps 7 - 9)</u>	<u>Hardware (Steps 7 - 9)</u>
Floor Runners (1 1/2" x 3 1/2" x 68 3/16") x 10	S1 - 2 1/2" Screws x 60 total



Foundations

Note: The floor will be flipped over and the floor runners will sit on your foundation. It is important to note, that having a level foundation is critical. Choosing a foundation will vary between regions. Typical foundations can be concrete pads or patio stones positioned underneath the floor runners.

9. Complete remaining Floor Runners.

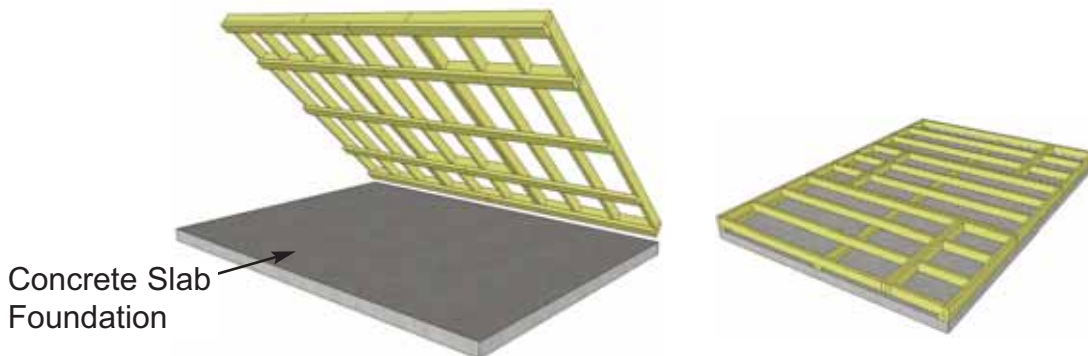

10. With Floor Runners attached, carefully flip the floor over and place on your foundation.

Caution: you will need 2 people to assist you. Be careful when laying floor down not to bend or twist floor. When in place, level floor completely.

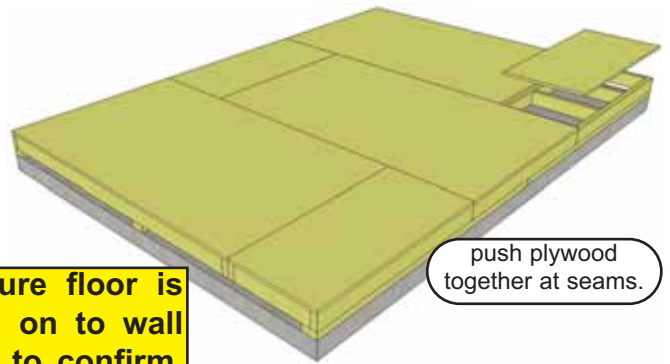
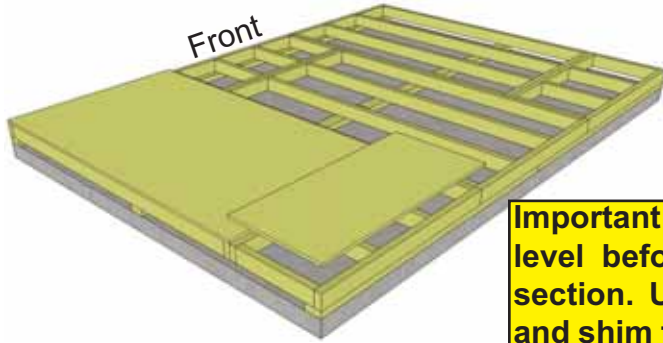

Important - Make sure floor is level before moving on to wall section. Use a level to confirm, and shim floor joists as required.

push plywood together at seams.

Hint: Use a chalk line to mark location of floor joists to determine screw placement.

11. Position all **Large & Small Plywood Floor** pieces on top of completed floor joists. Plywood will sit flush with outside of floor joist frame.

Parts (Steps 11 - 12)	Hardware (Steps 11 - 12)
Plywood Floor - Large (45 3/8" x 74 7/8") x 3	S2 - 1 1/4" Screws x 70 total (approx)
Plywood Floor - Small (45 3/8" x 20 7/8") x 3	

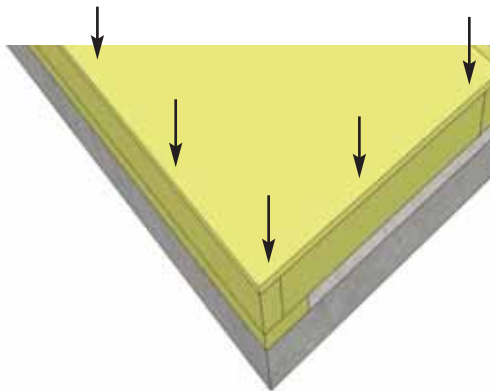
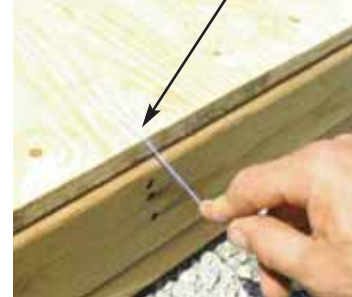

12. With Plywood positioned correctly on floor framing, attach with **1 1/4" Screws**. Use screws every 16".

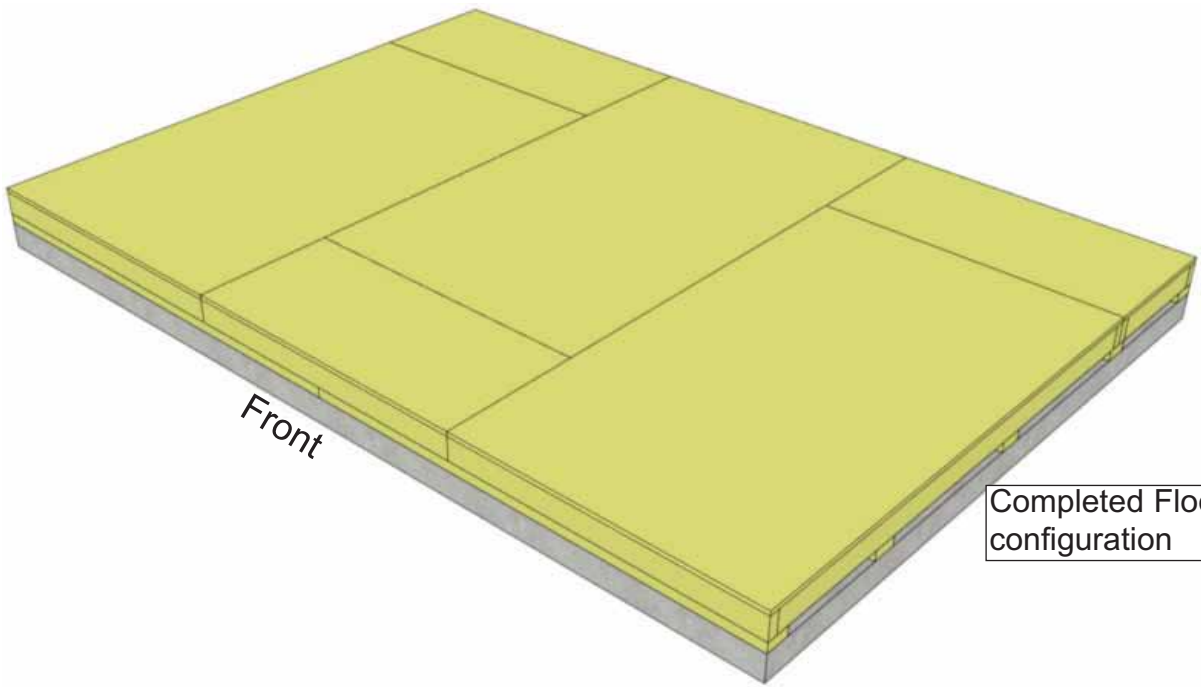

Completed Floor configuration

B. Wall Section

Exploded view of all parts necessary to complete the Wall Section.
Identify all parts prior to starting.

Side Top Plates (6)
(4 Angle cut on one end and 2 square cut.)

Front and Rear Top Plates (4)
(Angle cut on edge)

Gable Walls (4)

Window Wall Panel (2)

Narrow Wall Panel (12" wide)

Door Header

Door Jamb

Solid Wall Panels (7)

Bottom Wall Plates (7)

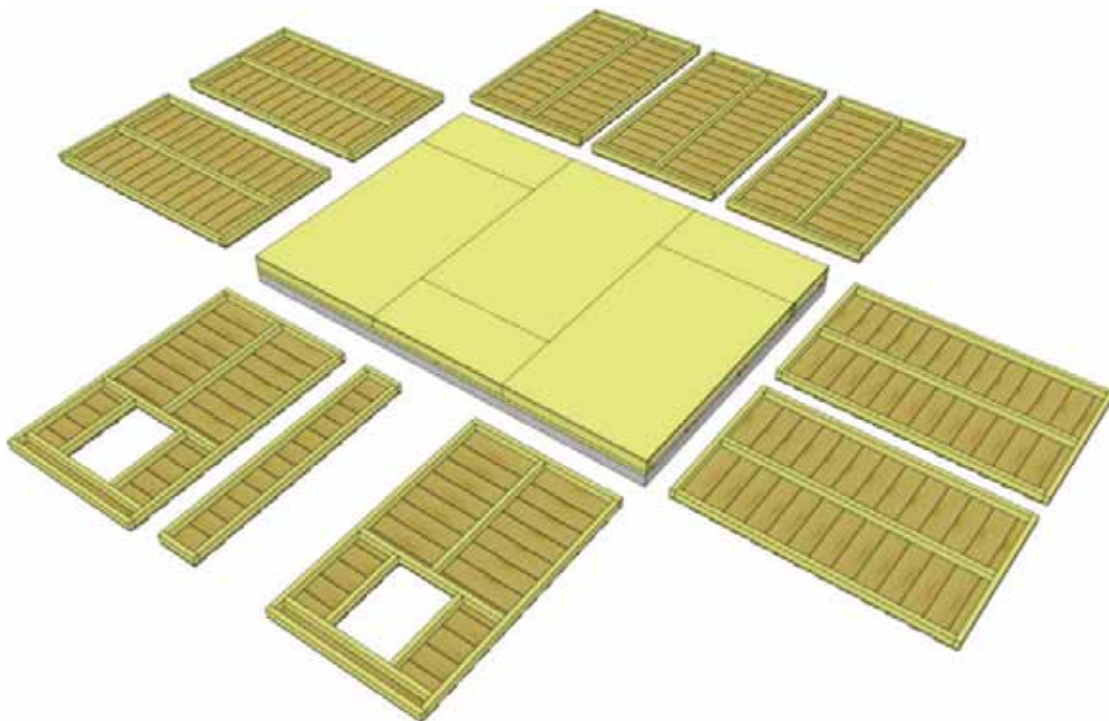

13. Lay out all the wall panels and become familiar with their location.

On Standard Kits, there are **2 Window Wall Panels, 7 Solid Wall Panels and 1 Narrow Wall Panel.**

Make sure to position panels right side up so water is directed away from and not into shed. Look at window wall panels to determine proper wall position to confirm.

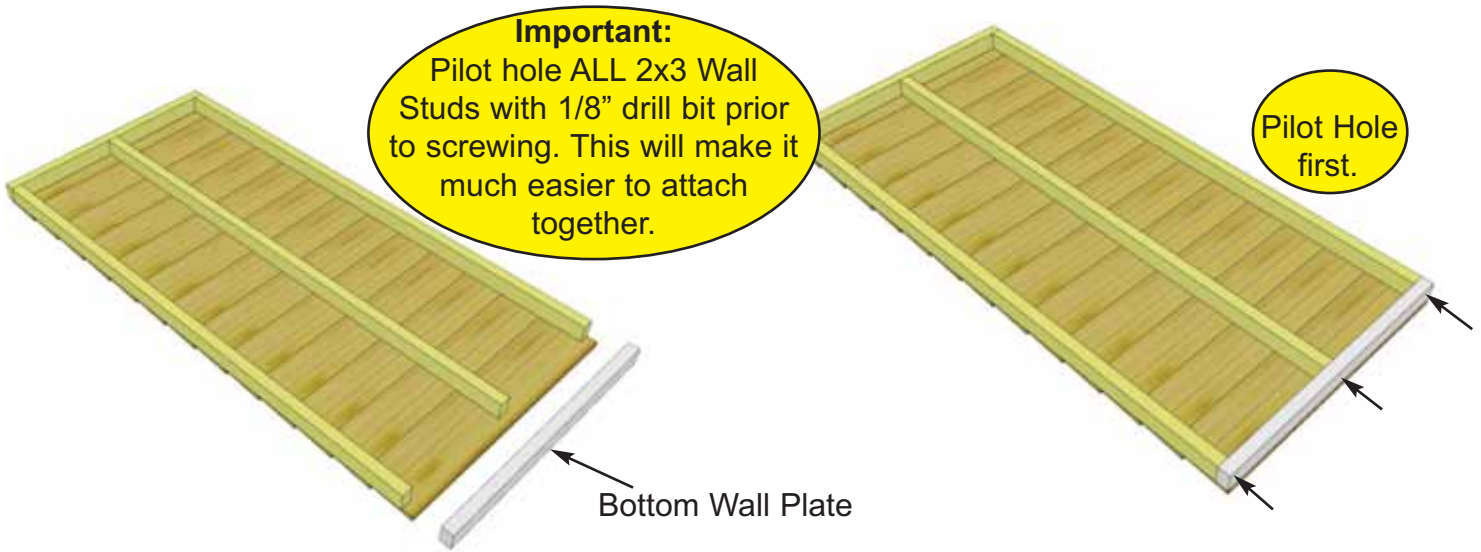

14. For each **Solid Wall Panel**, carefully lay panel face down. Position and attach a **Bottom Wall Plate** to bottom of wall studs of each wall panel with **3 - 2 1/2" Screws**. Position so plates are flush with framing.

Parts
Solid Wall Panels (45 1/2" x 75") x 7
Bottom Wall Plates (1 1/2" x 2 1/2" x 45 1/2") x 7

Hardware
S1 - 2 1/2" Screws x 21 total

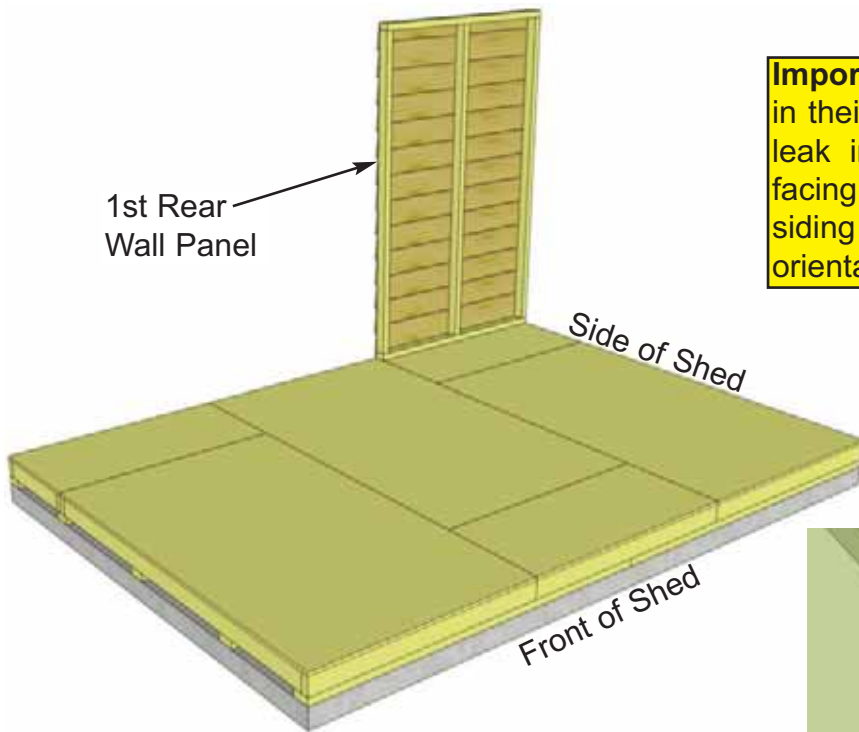

Important - Make sure all walls are aligned in their upright position. If not, water may leak into your shed. Unsure if panel is facing up or down? Compare solid wall siding to window wall siding and match orientation.

15. Starting at Rear Corner, position a Solid Wall Panel on top of plywood floor. The Wall Panel bottom framing will sit flush with plywood. Wall siding will overhang the floor. The Rear Wall panels will sit flush at the end of the plywood floor with the side wall panels sandwiched between them

Note: Siding will overhang the floor by approximately 1/2".

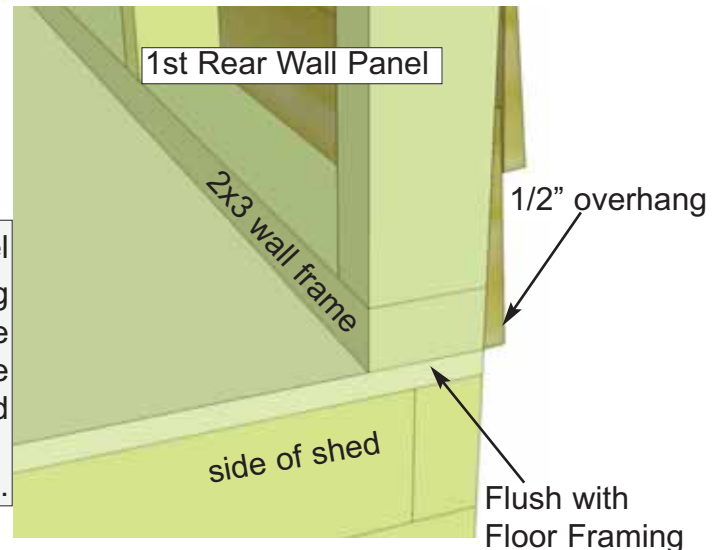

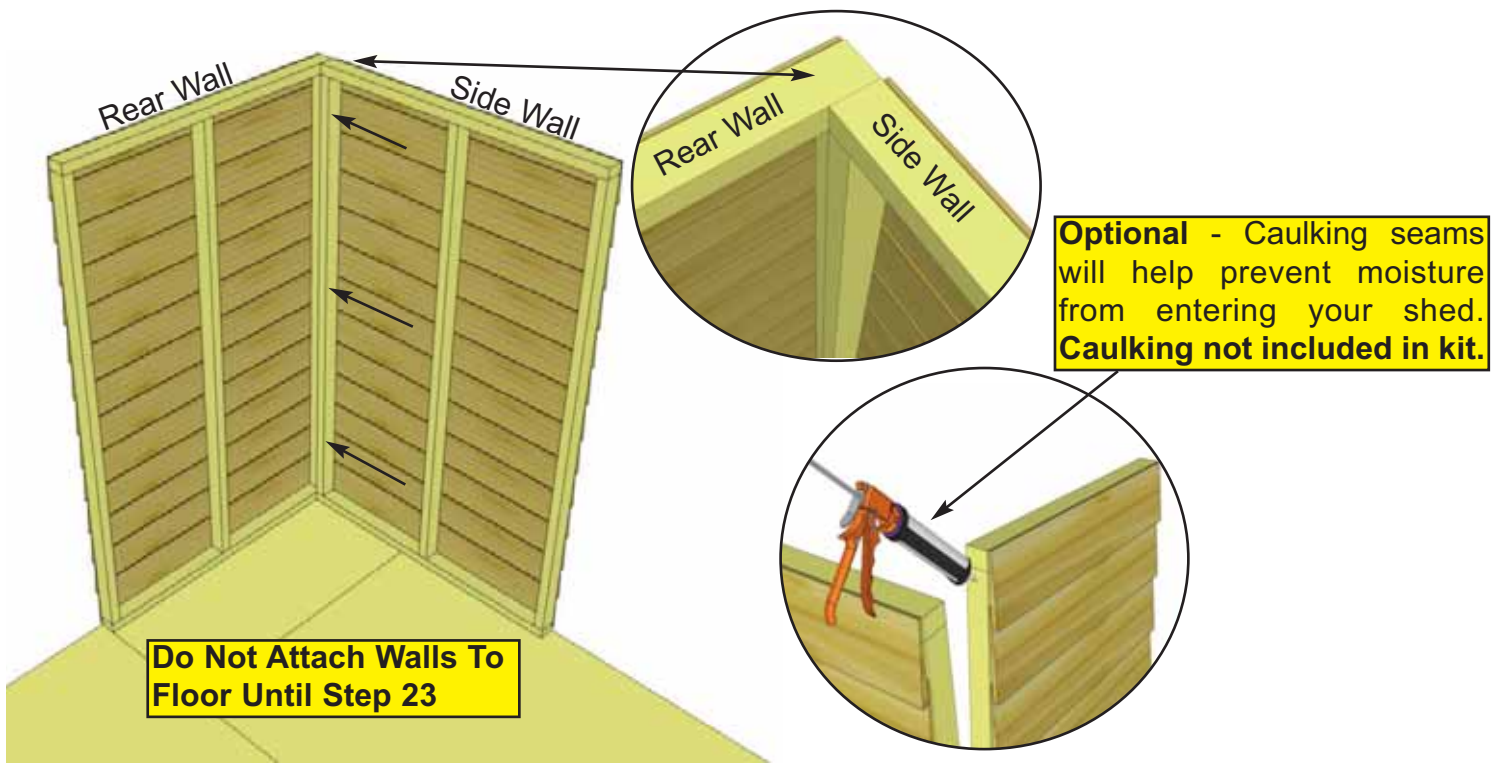

16. Position side solid wall into place on plywood floor. Butt both vertical wall studs of side and rear walls together and attach with **3 - 2 1/2" Screws**. Screw at the bottom, middle and top of stud to secure properly.

Hardware (Steps 16 -18)
S1 - 2 1/2" Screws
 x 18 total

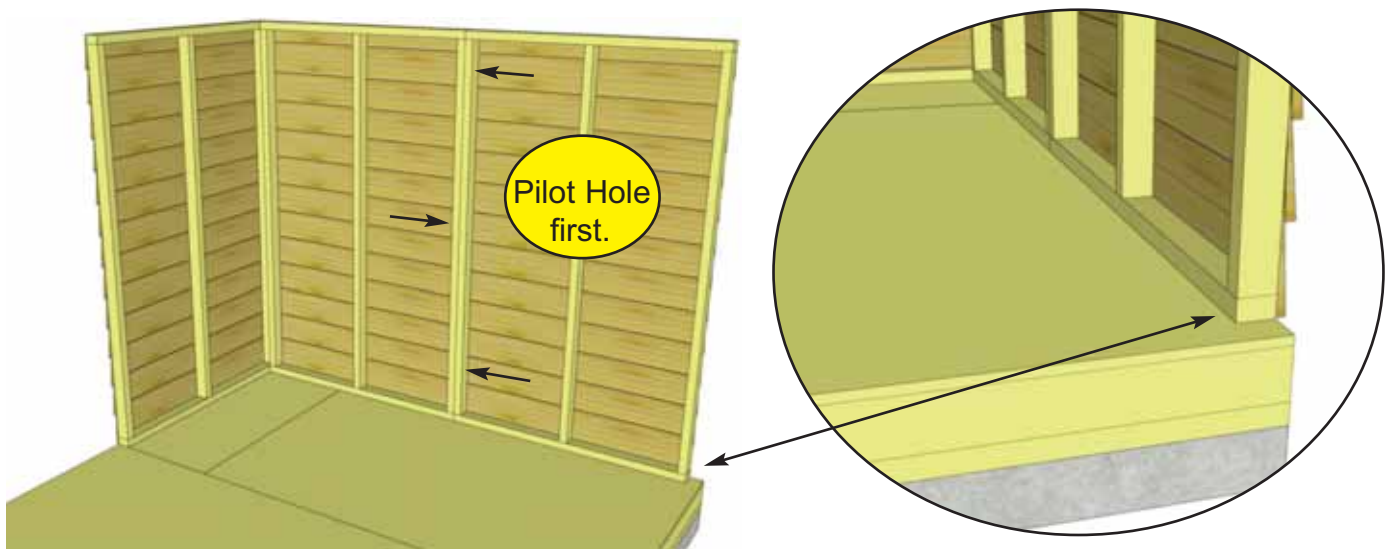

17. With the corner wall attachment complete, position a second Side Wall panel in place so bottom 2x3 wall framing is sitting flush with outside floor joists and plywood floor. Wall siding should overhang floor by approximately 1/2". When positioned correctly, attach both Side Wall panel studs together as shown.

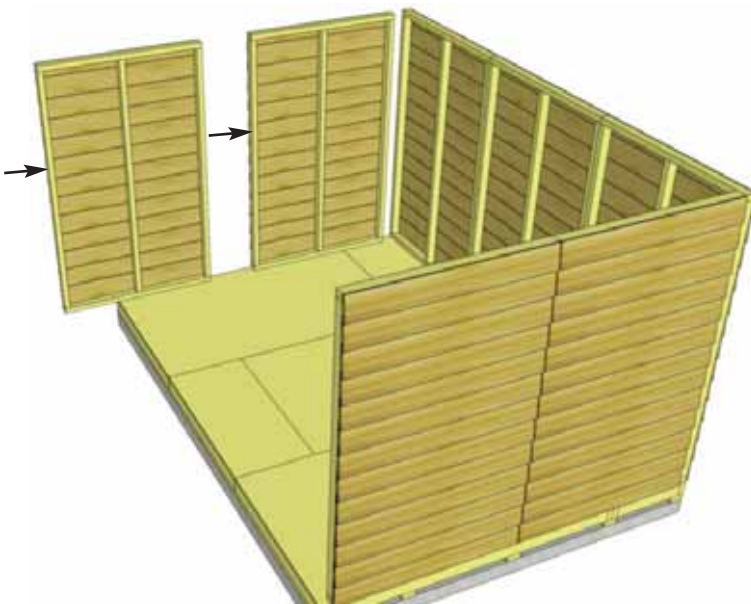
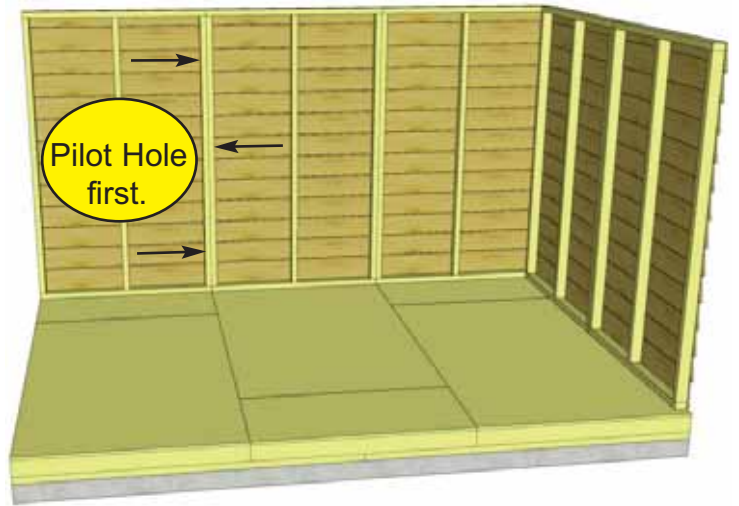
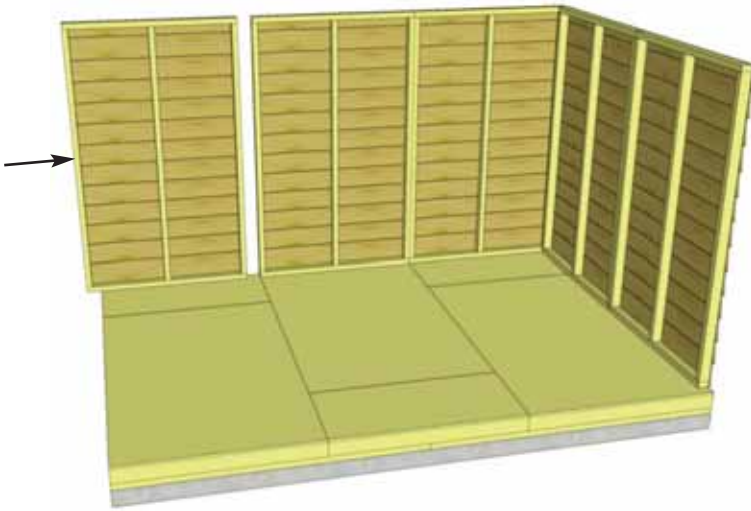
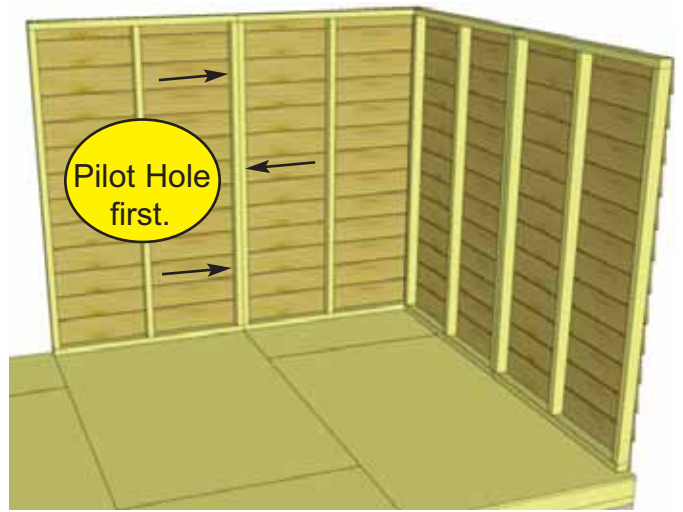

18. Complete all **Side** and **Rear Wall** attachments as per **Steps 15 - 17.**

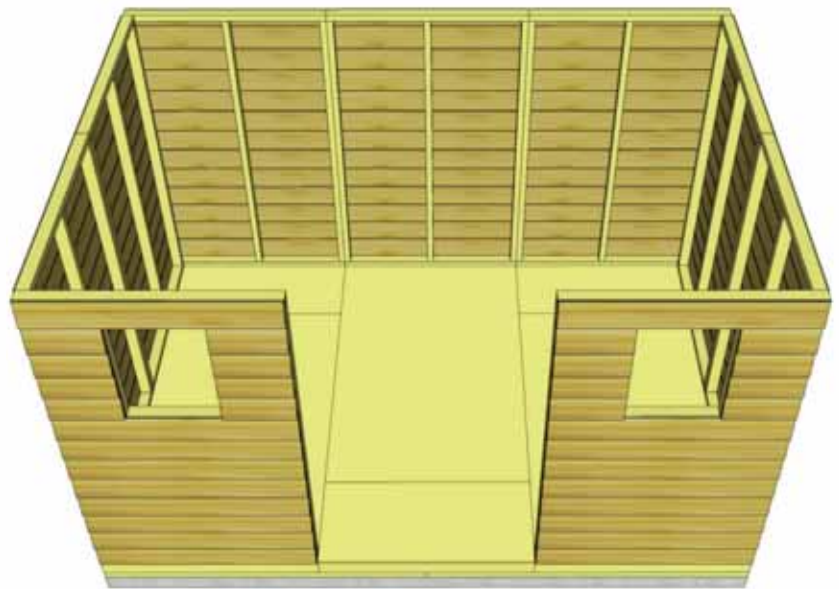
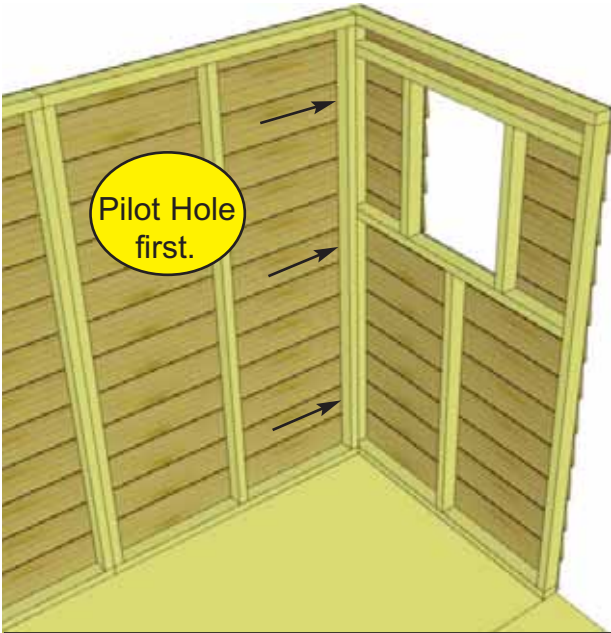
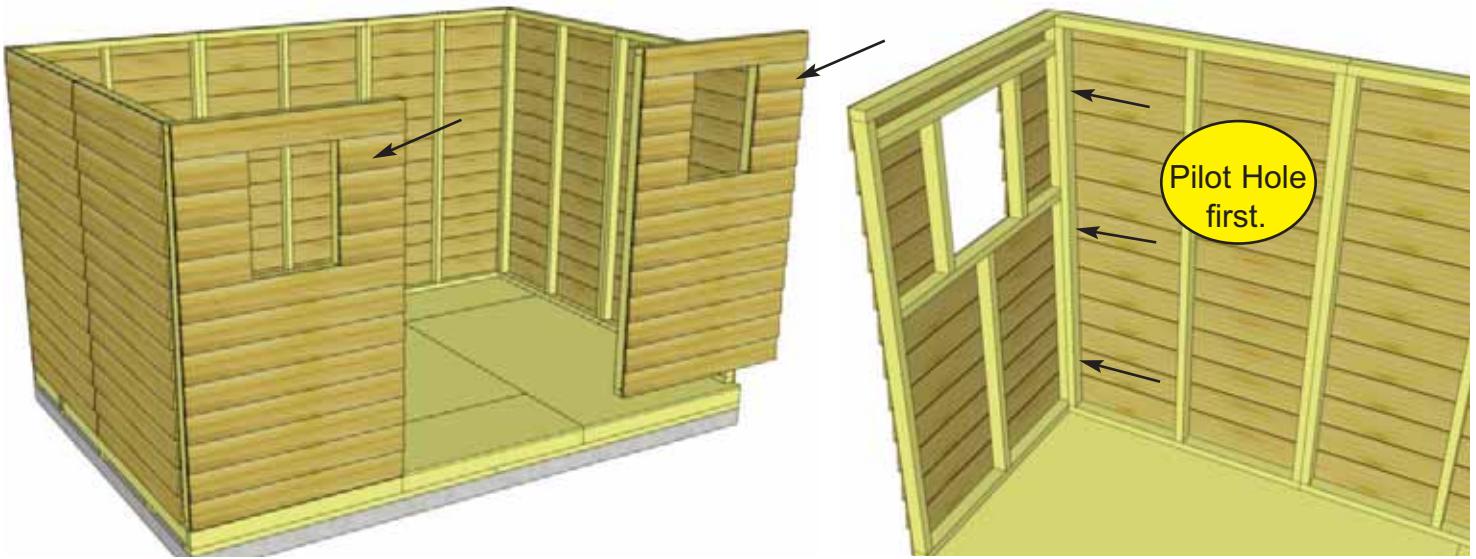

19. Position and attach both **Window Walls** as per **Steps 15 - 18.**

Parts
Window Walls
(45 1/2" x 75") x 2

Hardware
S1 - 2 1/2" Screws
x 6 total

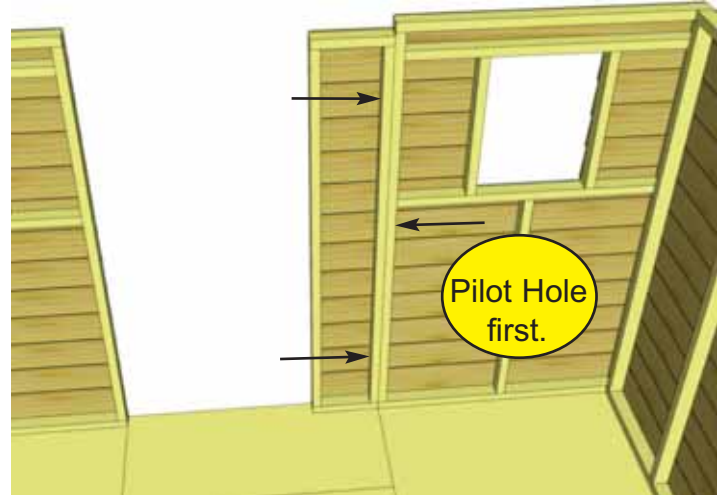
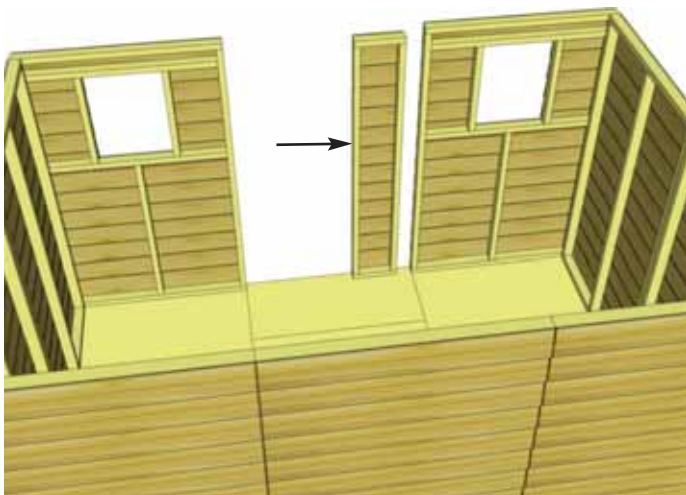

20. Position and attach **Narrow Wall** as per **Steps 15 - 18.**

Parts
Narrow Wall
(12" x 73") x 1

Hardware
S1 - 2 1/2" Screws
x 3 total

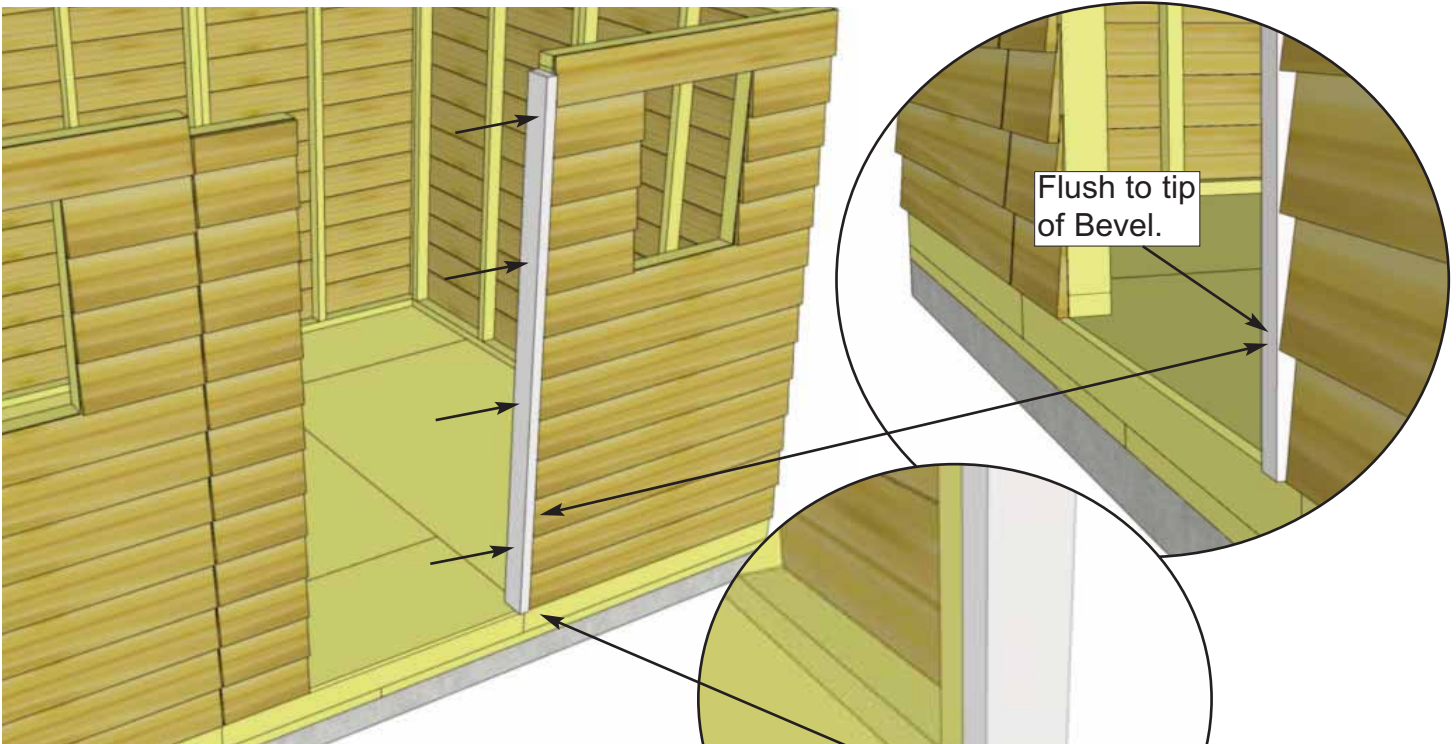

21. Attach **Vertical Door Jamb** to Window Wall stud in door opening with **4 - 2 1/2" Screws**. Position so Jamb is flush with tip of bevel siding on front Window Walls.

Parts	Hardware
Vertical Door Jamb (1 1/2" x 3 1/2" x 73") x 1	S1 - 2 1/2" Screws x 4 total

Flush with Window Wall stud on inside.

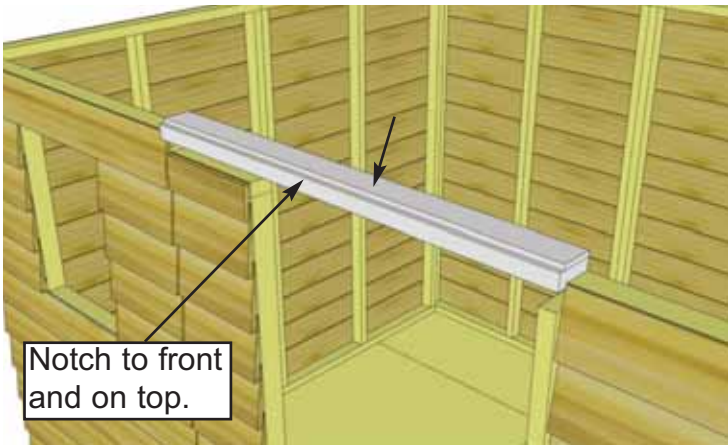

22. Attach **Door Header** to Vertical Door Jamb and Narrow Wall with **2 - 2 1/2" Screws** per side. Header is 3 1/2" wide at bottom and has a 1/2" thick x 3" wide strip of wood stapled to the top creating a notch or dado effect. This notch needs to be positioned on the top facing the front. The notch is necessary as the roof panel may hang up on the Header and must sit flush on the rafter tops when attached. **Pre-drill to prevent splitting!**

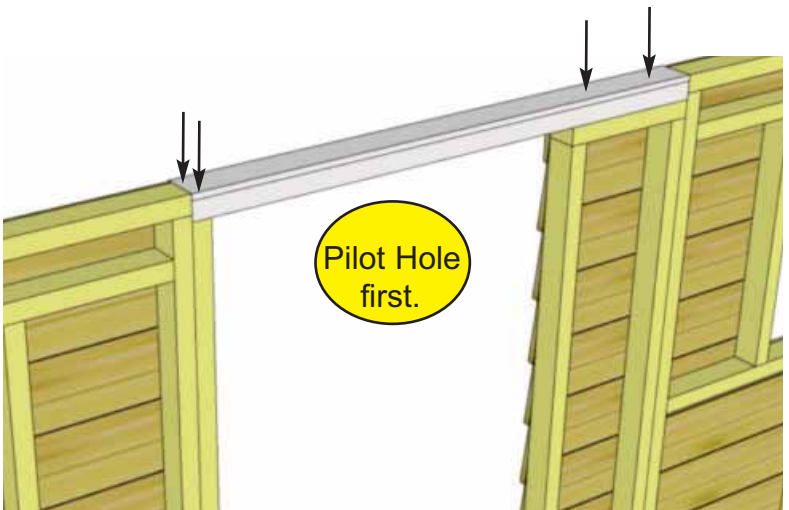

Parts
Door Header (2" x 3 1/2" x 45 1/2") x 1
Hardware
S1 - 2 1/2" Screws x 4 total

Advice: Prior to fastening walls and installing rafters, take time to confirm your walls are level, square and plumb.

Measure diagonal at top and bottom of walls corner-to-corner. This should be approximately 159 7/8". More importantly, if measurements are not within 1/4", your walls are not square. Adjusting now will make it easier to install roof section.

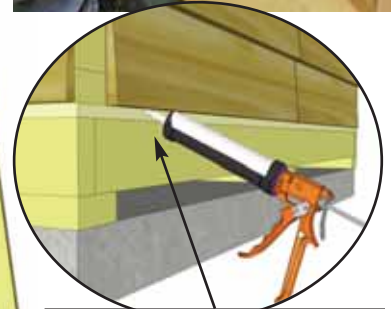
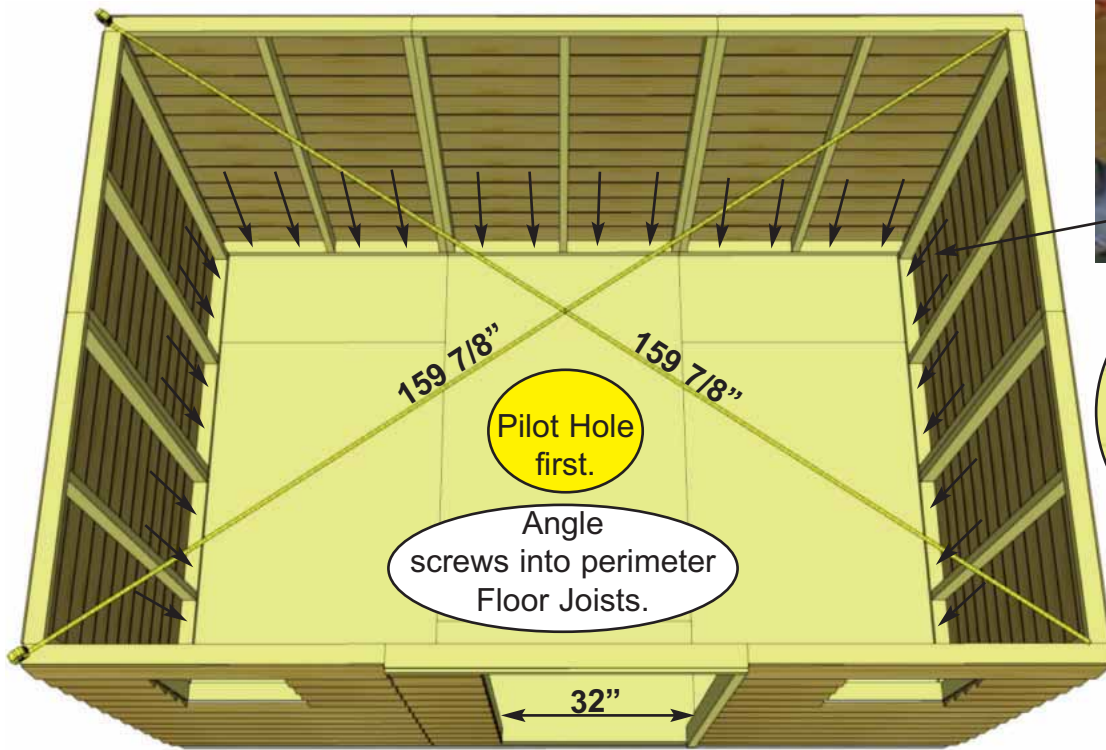

Optional - Caulking seams will help prevent moisture from entering your shed. **Caulking not included in kit.**

23. When all walls are attached together, check alignment with the floor. Bottom of wall frames should sit flush with outside of floor framing, with siding overhanging by approximately 1/2". Confirm 32" wide door opening at bottom. When positioned correctly, fasten Bottom Wall Plates to floor using **4 - 2 1/2" Screws** per wall panel.

Hardware
S1 - 2 1/2" Screws
 x 38 total

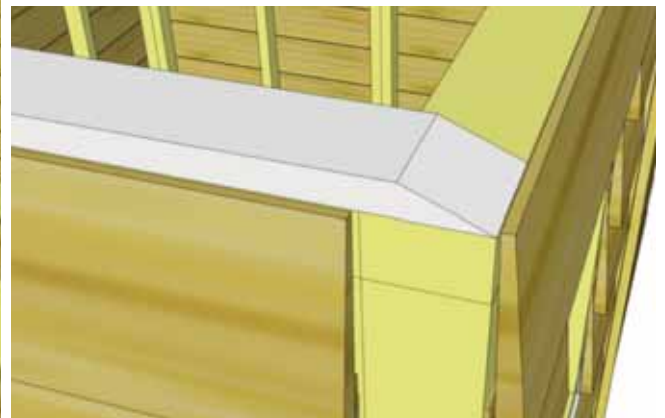
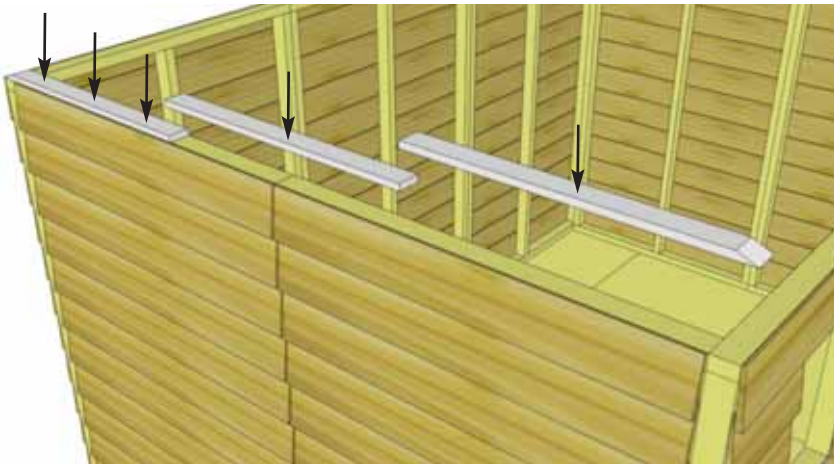

24. Position **Side Top Plates** (one side only) on top of wall studs so they are flush on the inside. There are 3 Side Top Plate pieces per side (2 angle cut on one end and one straight cut - both ends). Together, the plates should be centered evenly on the wall left to right. Attach by screwing down into top wall framing with **3 - 2" Screws** per plate.

Parts (Steps 24 - 25)

Side Wall Top Plates - 4 Angle Cut End, 2 Straight Cut
 (3/4" x 2 1/2" x 32") x 6

Front & Rear Wall Top Plates - Angle Cut Edge
 (3/4" x 2 1/2" x 65 3/4") x 4

Hardware (Steps 24 - 25)

S3 - 2" Screws
 x 34 total

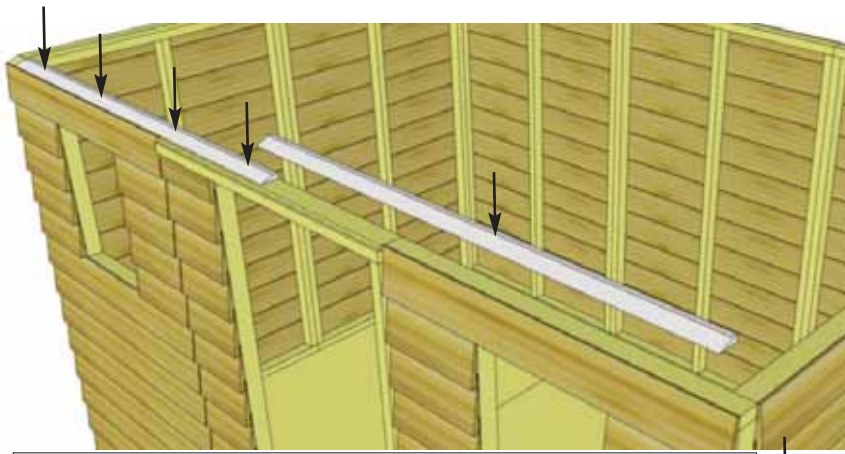

25. Next, attach the **Front Top Plates**. The Front and Rear Top Plates are angle cut down the length. Once again, position Top Plates on wall frame so they are flush. Front and Rear Top Plates will fit between Side Top Plates. Attach with **4 - 2" Screws** per plate. Complete all other **Side & Rear Top Plate** attachments the same.

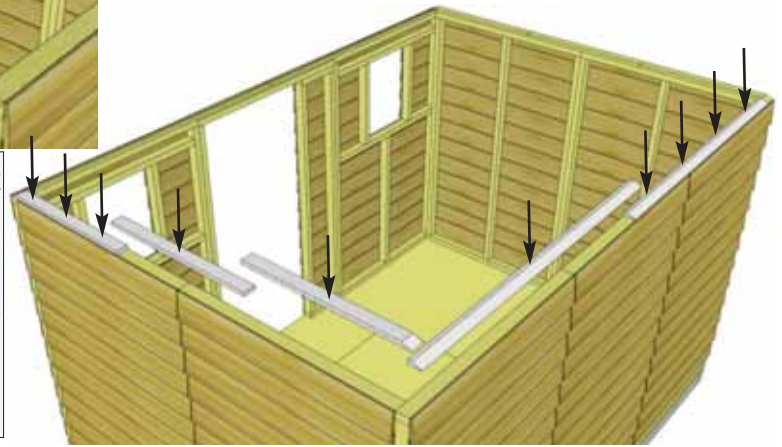

Male / Female Gable Siding Overlap

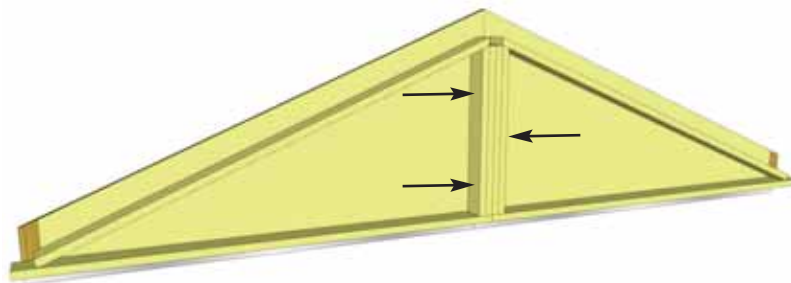
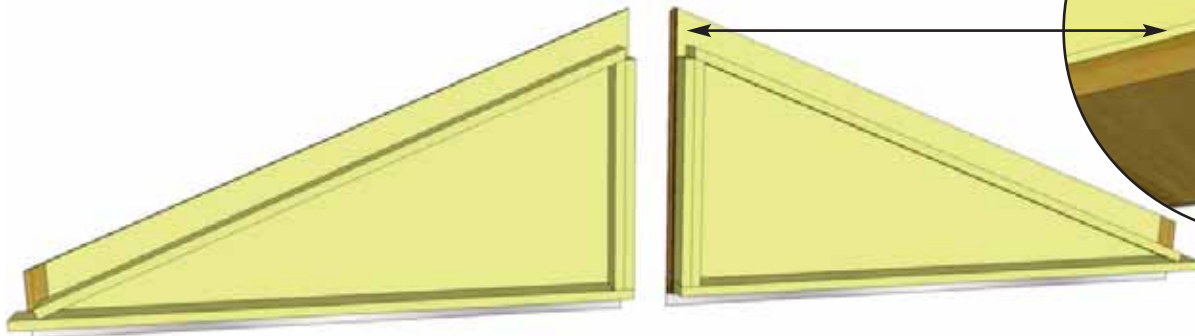

26. Locate **Triangular Gable Half Walls** for both sides of the shed. Align framing and wall siding lap together. Screw center wall framing of each piece together with **3 - 2 1/2" Screws**. **Note:** Prior to attaching, try each combination of Gables for best fit.

Parts

Triangular Gable Half Walls x 4

Hardware

S1 - 2 1/2" Screws x 6 total



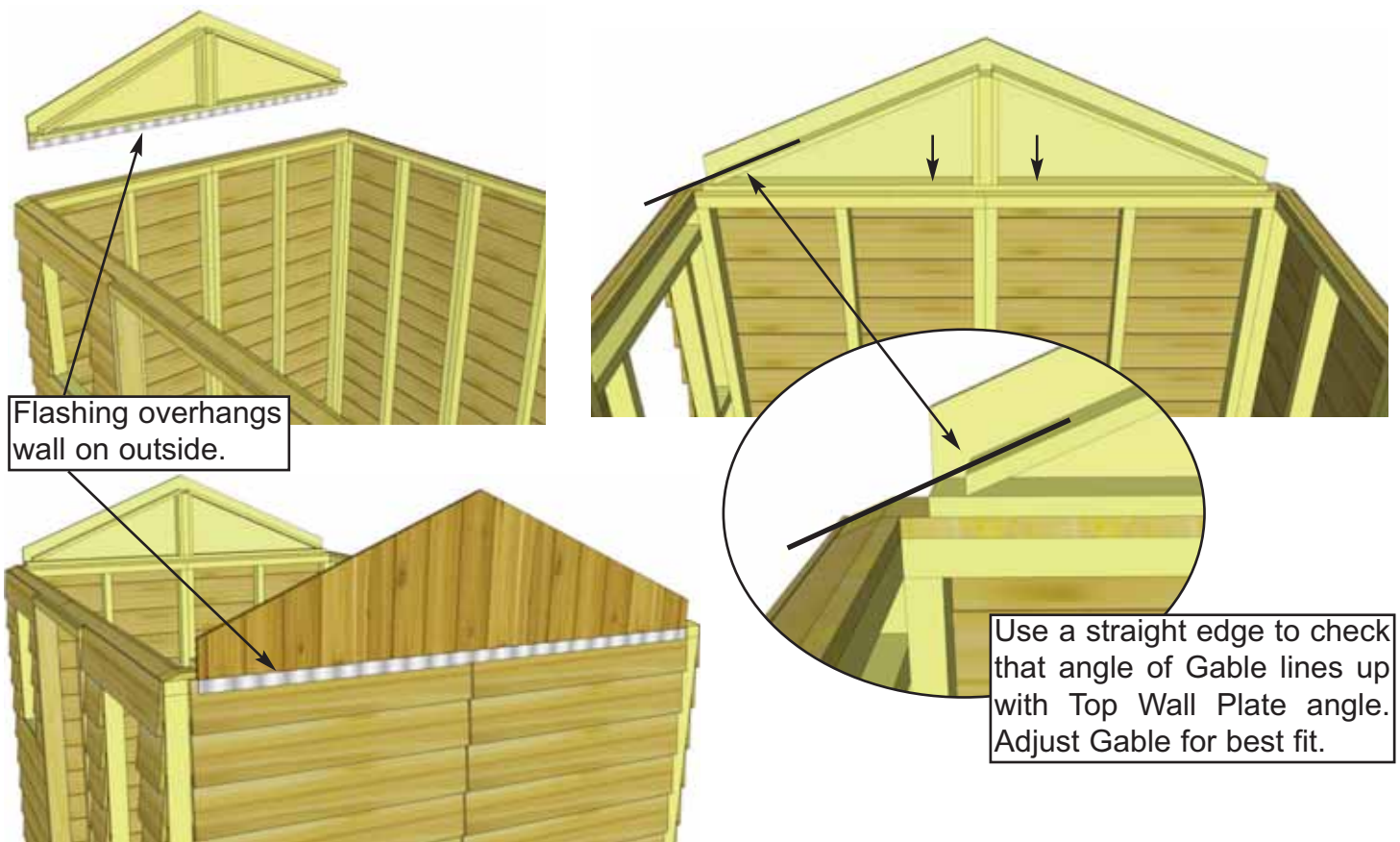

27. Place completed Gable section so framing sits flush with the inside of the Top Wall Plate. It should also be centered side-to-side on the Top Wall Plate. Gable Flashing overhangs wall on the outside. Temporarily attach to Gables and Top Wall Plate with **2 - 2" Screws**. Gables may need slight adjustment in **Step 37** when attachment will be completed with an additional 6 Screws. Screw from the bottom of Gable framing down into Top Wall Plate and Wall Framing. Complete Gable positioning and attachment on the other side.
Hint: Use a straight edge to check the angle of the Gable framing and Top Plate. Both angles should line up (see diagram above).

Hardware
S3 - 2" Screws x 4 total

C. & D. Rafter and Roof Section

Exploded view of all parts necessary to complete the Roof Section.
Identify all parts prior to starting.

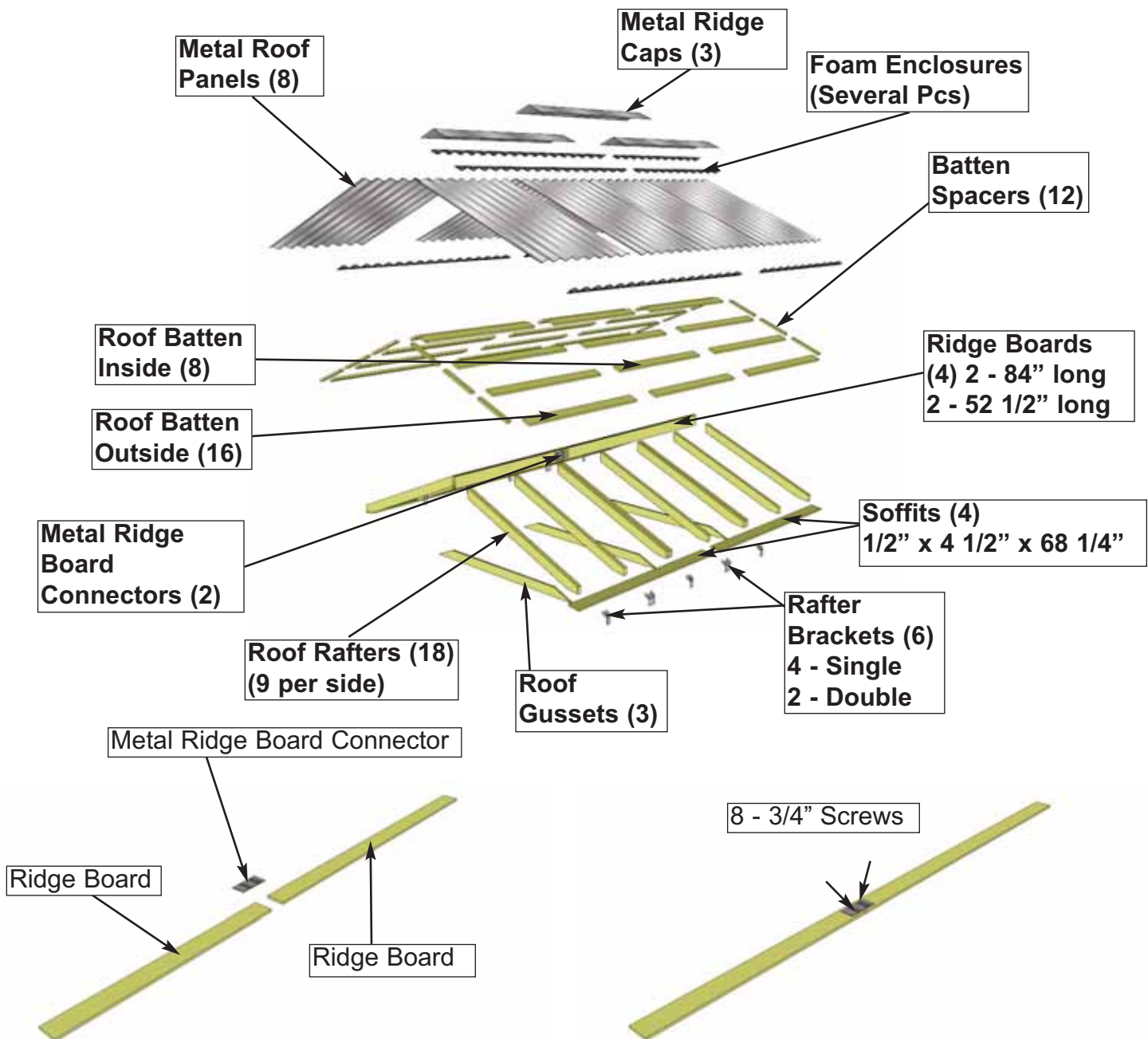

28. Locate **Ridge Boards Long & Ridge Boards Short** and attach together with **Metal Ridge Board Connector** using **8 - 3/4" silver screws**. Position **Metal Ridge Board Connector** evenly on **Ridge Boards**. Total length when connected is **136 1/2"**. Complete two sets.

Parts (Step 28)
Ridge Board Long
 (3/4" x 4 1/2" x 84") x 2
Ridge Board Short
 (3/4" x 4 1/2" x 52 1/2")
 x 2

Hardware (Step 28)
SS2 - 3/4" Screws
 x 16 total

29. Locate **9 - Rafters**, **2 - Soffits** & completed **Ridge Board**. Lay out on level ground as shown to the right. Double up **Rafters** as illustrated. Screw doubled up **Rafters** together with **3 - 2 1/2" screws** per piece. **Note:** completed Rafer section will be flipped over in **Step 38**.

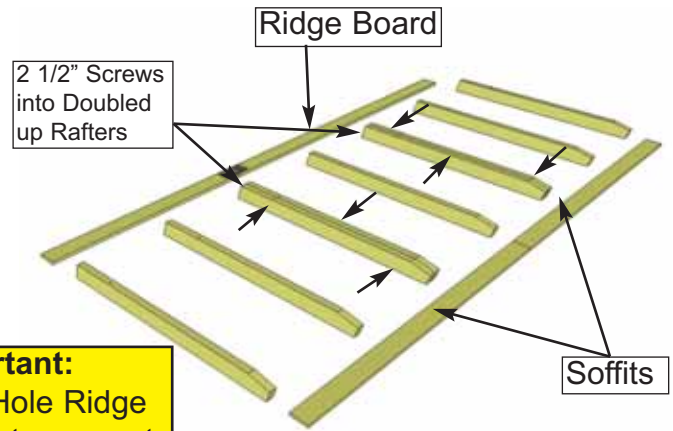

Parts (Steps 29 - 31)

Rafters

(1 1/2" x 3 1/2" x 56 1/2") x 18

Soffits

(1/2" x 4 1/2" x 68 1/4") x 4

Hardware (Steps 29 - 31)

S1 - 2 1/2" Screws

x 16 total

S2 - 1 1/4" Screws

x 16 total

S3 - 2" Screws

x 16 total

Important:
Pilot Hole Ridge Board to prevent splitting!

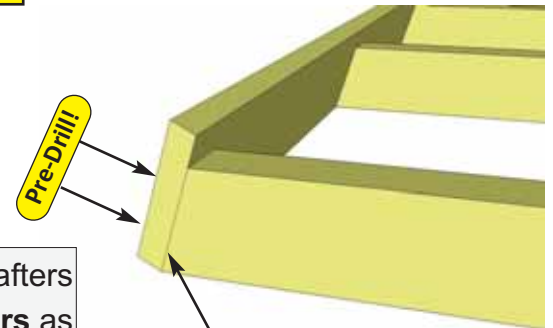

30. Attach completed **Ridge Board** to ends of both outside rafters with **2 - 2" screws** per end. Measure and position interior **Rafters** as illustrated below. When positioned correctly, attach **Ridge Board** to remaining rafters with **2 - 2" screws** per **Rafter** end.

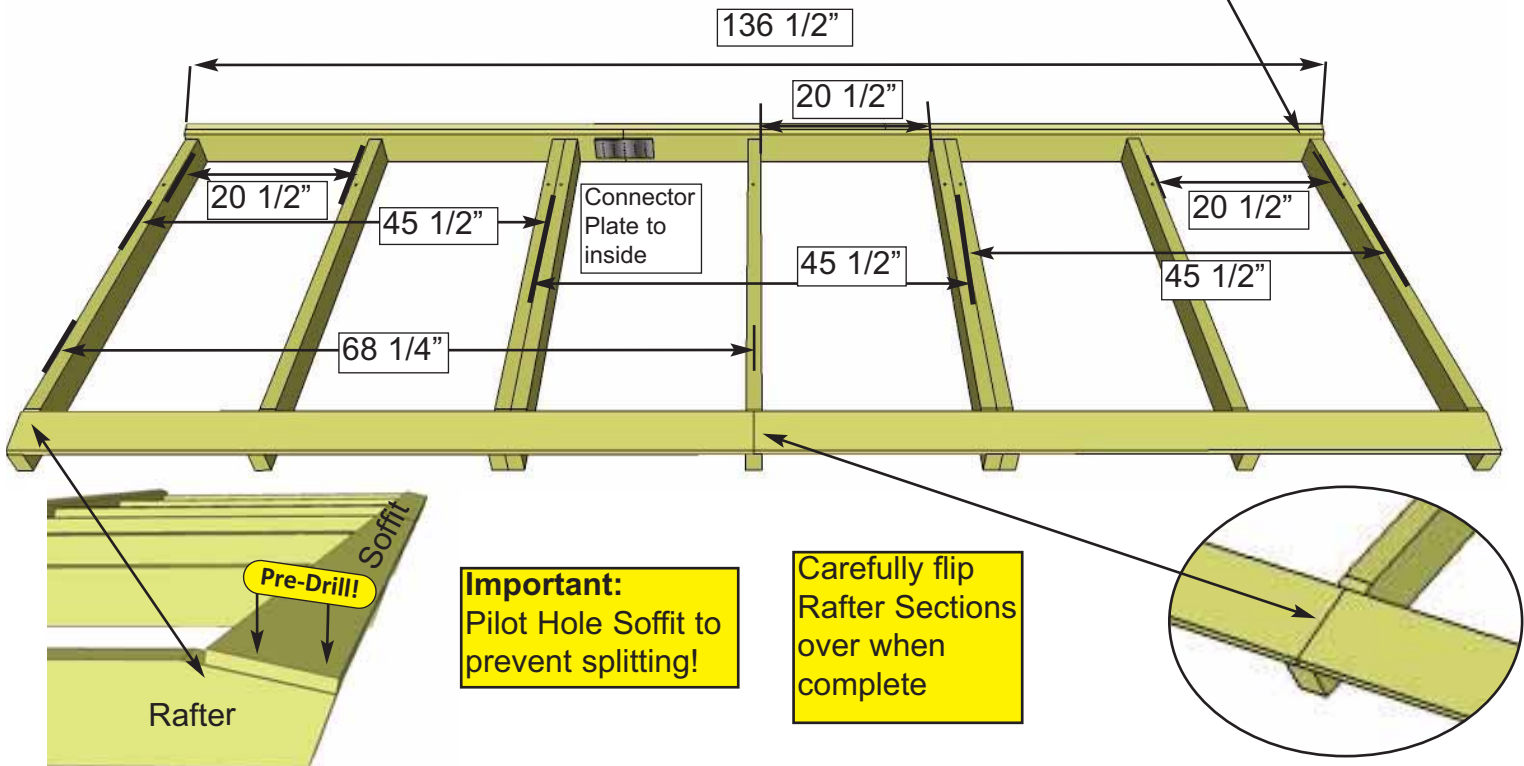

31. Attach end of a **Soffit** Board flush to ends of outside **Rafters** with **2 - 1 1/4" screws** per rafter end. Drill pilot hole in **Soffit** ends to prevent splitting. Complete both outside **Rafter** & **Soffit** connections first. Measure and position interior **Rafters** as illustrated above. When positioned correctly, attach **Soffits** to remaining **Rafters** with **2 - 1 1/4" screws** per **Rafter**. Flip completed **Rafter** section over. Complete 2nd **Rafter** section now as per **Steps 35 - 38** with the following exception. **When attaching Ridge Board to Rafter ends, make sure Ridge Board Connector is positioned offset to first Rafter Section. See Step 45 for illustration.**

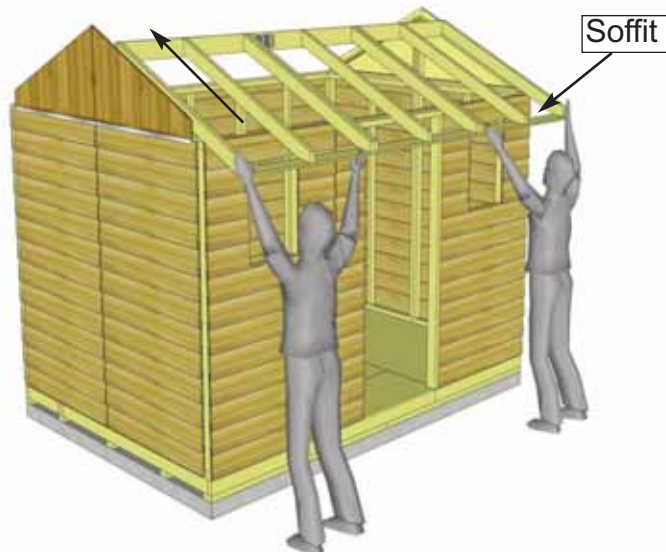

32. Carefully lift 1 completed **Rafter** Section up (make sure **Soffit** is facing down) and place on gable framing.

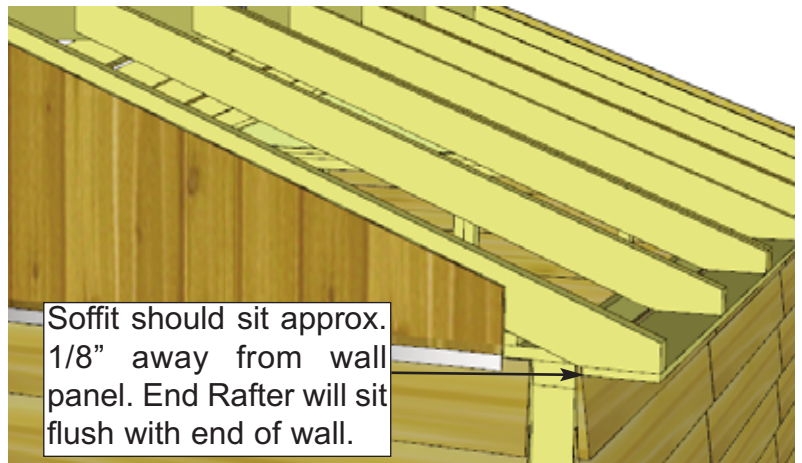
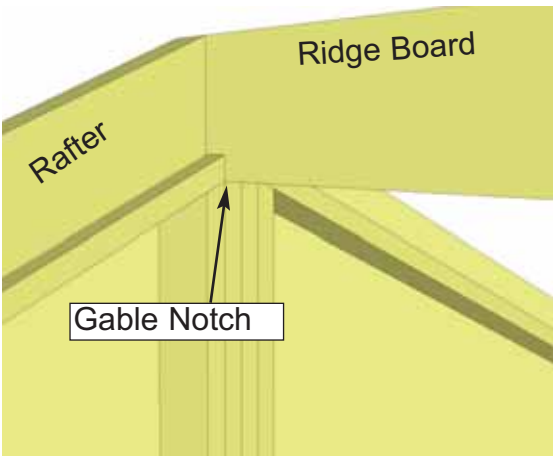

33. Slide **Rafter** Section up on gable framing until bottom of **Ridge Board** slips into gable notch. **Soffit** will sit approximately 1/8" away from wall panel.

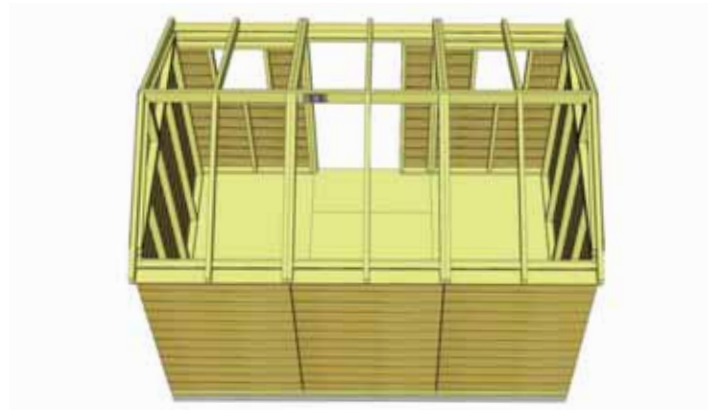
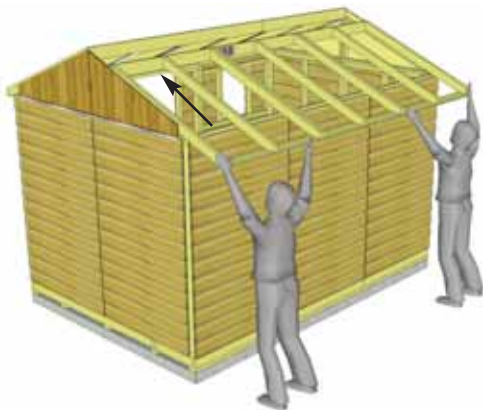

34. Place second completed Rafter Section on Gable Walls as per **Steps 32 - 33.**

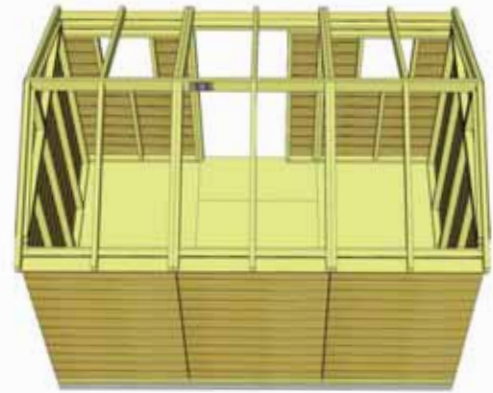
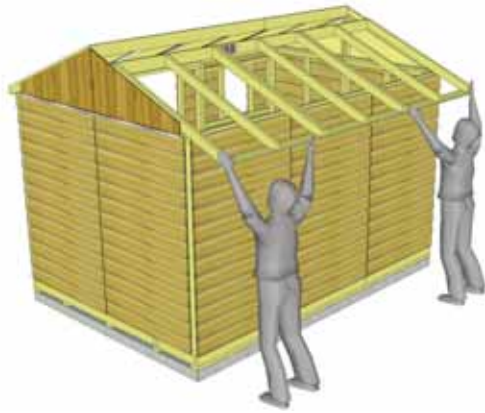

34. Place second completed Rafter Section on Gable Walls as per **Steps 32 - 33**.

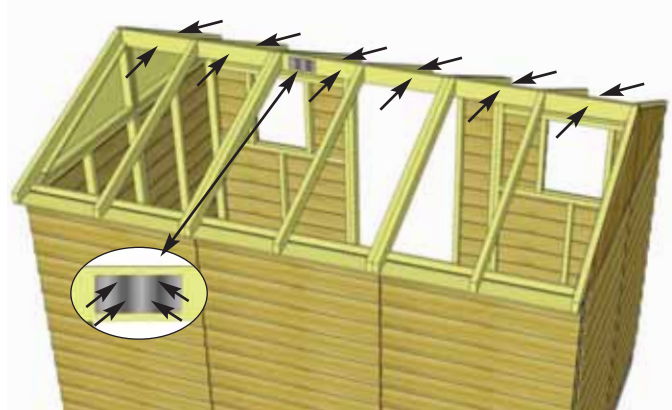
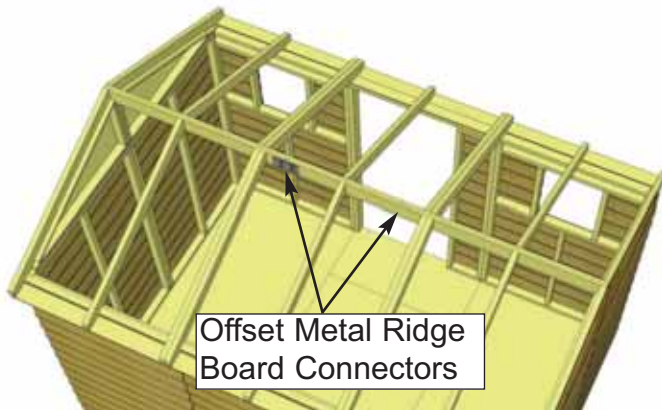

35. At the peak, align Ridge Boards so they are flush together and secure them with 12 - 1 1/4" screws. To completely secure Ridge Boards, place **4 - 1 1/4" screws** into any of the remaining **Metal Ridge Board Connector** holes. Complete both sides. **Important:** If there is a gap between **Ridge Boards**, try pushing side walls closer together from outside. Walls should be 91" apart at top from inside of wall plate to wall plate.

Hardware (Step 35)
S2 - 1 1/4" Screws
 x 16 total

Important: If gable framing does not line up with Rafters, remove temporary 2" screws from Gable framing. Re-align gable and secure with 8 - 2" screws total.



36. With both **Ridge Boards** connected, completely secure **Rafters** to **Gable** framing of both **Gable Walls**. Use **8 - 2" screws** per gable.

Hardware (Step 36)
S3 - 2" Screws
 x 32 total

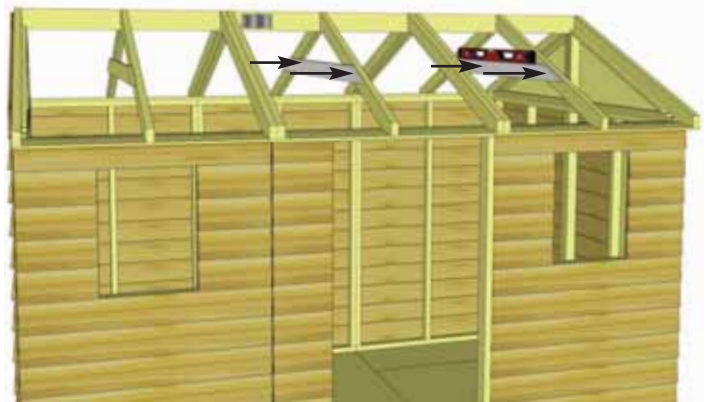
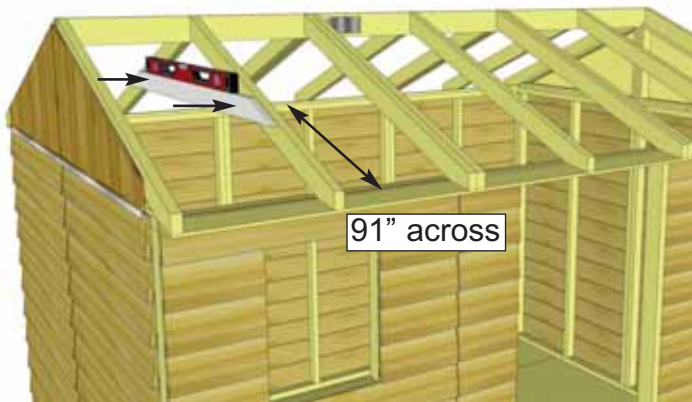

37. Roof Gussets are positioned on middle **Rafters**. Prior to attaching, make sure walls are properly aligned. Have two helpers push walls at the top from the outside of shed until inside to inside measurement between front and rear plates is 91". Use a level to square **Gusset**. Attach Gusset with 4 - 2" screws.

Parts Roof Gussets (3/4" x 3 1/2" x 72") x 3 Hardware S3 - 2" Screws x 12 total
--

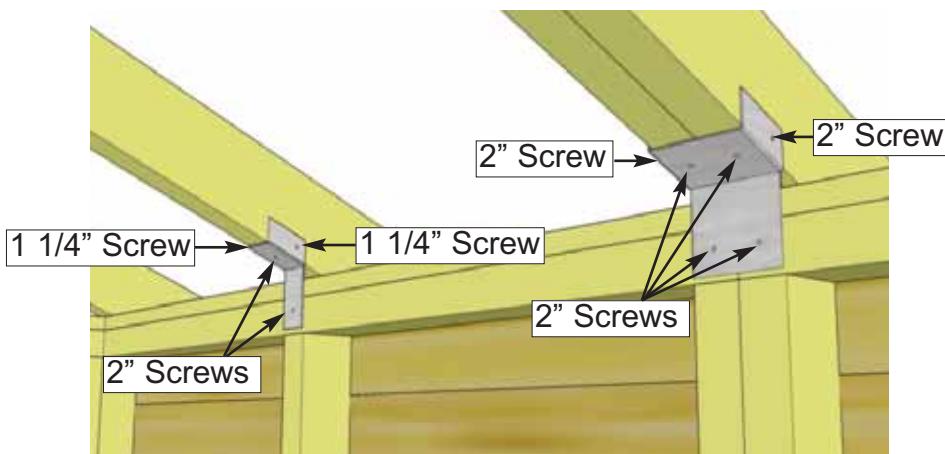

38. Attach all **Single** and **Double Rafter Brackets** where rafters meet **Top Wall Plates** inside of shed. Attach with 2 - 1 1/4" screws and 2 - 2" screws per **Single Bracket** and 6 - 2" screws per **Double Bracket**.

Hardware (Step 38) S2 - 1 1/4" Screws x 8 total S3 - 2" Screws x 20 total Y30 - Single Rafter Brackets x 4 total Y31 - Double Rafter Brackets x 2 total
--

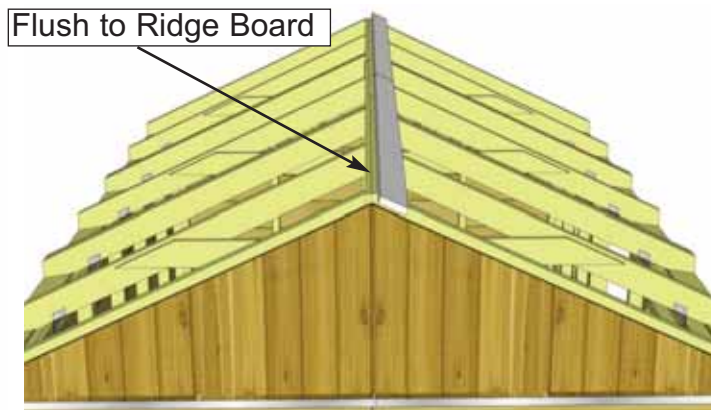
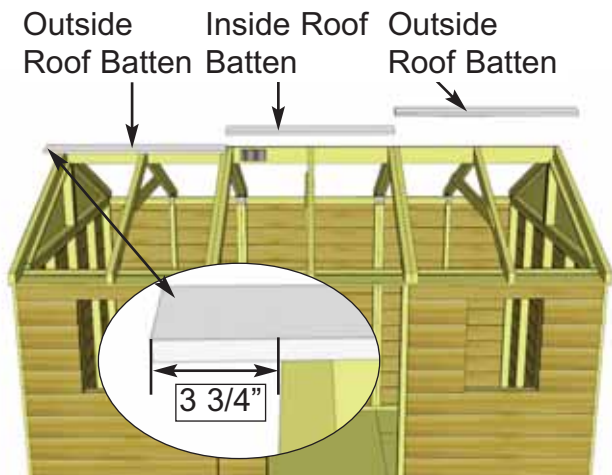

39. Locate 2 **Outside Roof Battens** and 1 **Inside Roof Batten**, place on Roof Rafters. Place at top of Rafter section where Rafters and Ridge boards meet. Battens should be positioned evenly on 3rd and 6th Rafters. Battens will overhang outside Rafter by 3 3/4".

Hardware (Steps 51 - 57)

S2 - 1 1/4" Screws
92 x total

Parts (Step 51 - 57)
Roof Battens Outside
(3/4" x 3 1/2" x 49 1/4") x 16
Roof Battens Inside
(3/4" x 3 1/2" x 45 1/2") x 8
Batten Spacer
(3/4" x 1 1/2" x 14 1/8") x 12

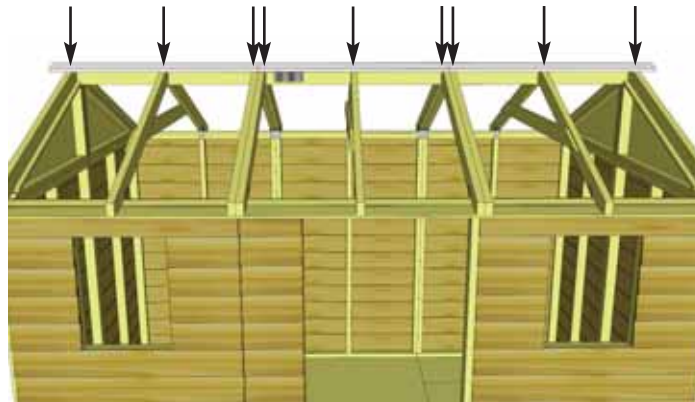
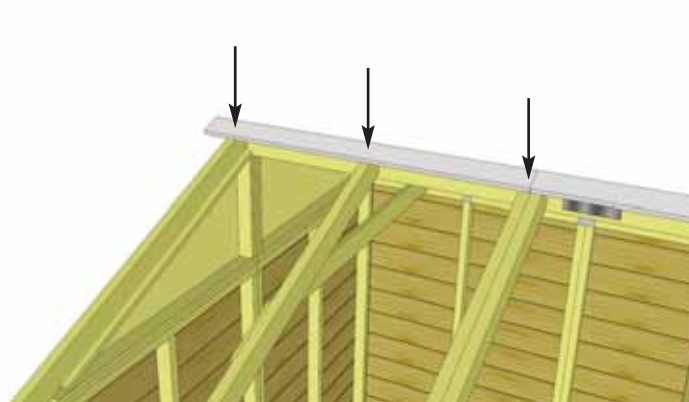

40. Attach each **Batten** to Rafters with **3 - 1 1/4" screws** per Batten. **Important:** pre-drill pilot holes with 1/8" drill bit first to prevent splitting.

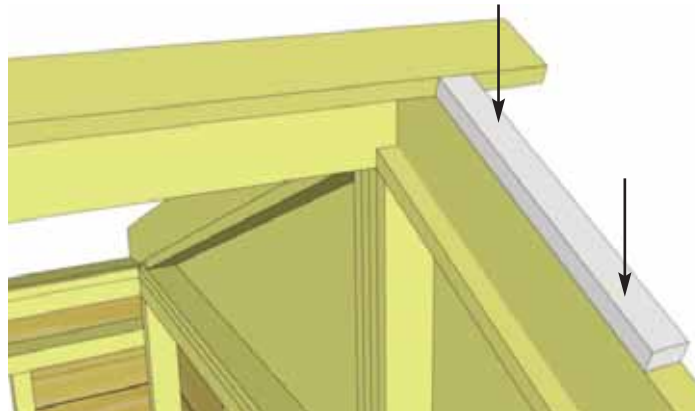
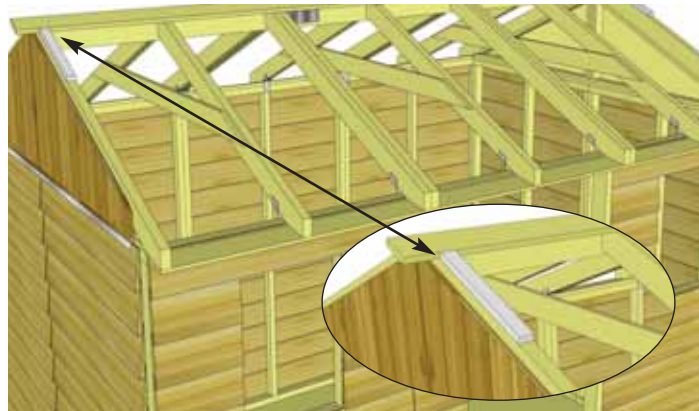

41. Place **Batten Spacer** flush with first set of Battens on outside Rafter. Batten Spacer allows you to line up next row of Battens. Attach each with **Batten Spacer** with **2 - 1 1/4" screws**.

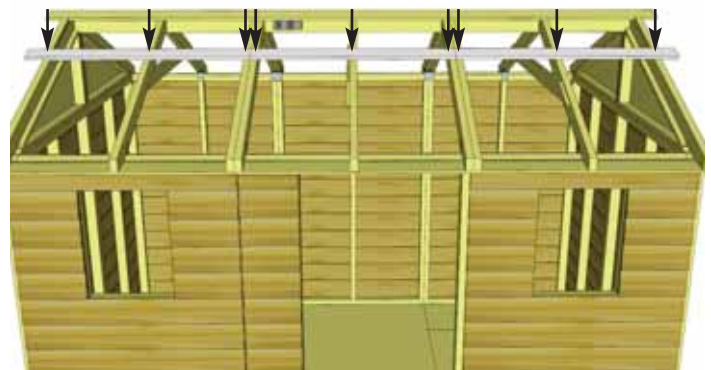
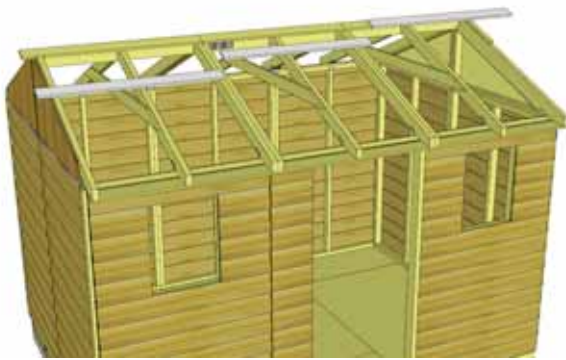

42. Locate **2 Outside Roof Battens** and **1 Inside Roof Batten**. Place outside Battens flush with Batten Spacers and overhanging outside Rafter by $3 \frac{3}{4}$ ". Secure row of Battens to Rafters with **9 - 1 1/4" screws** (3 screws per Batten).

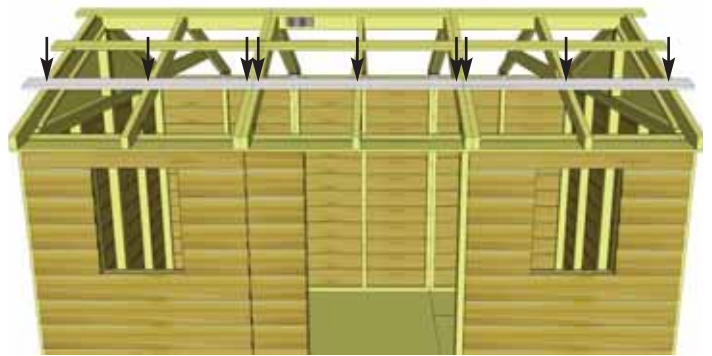
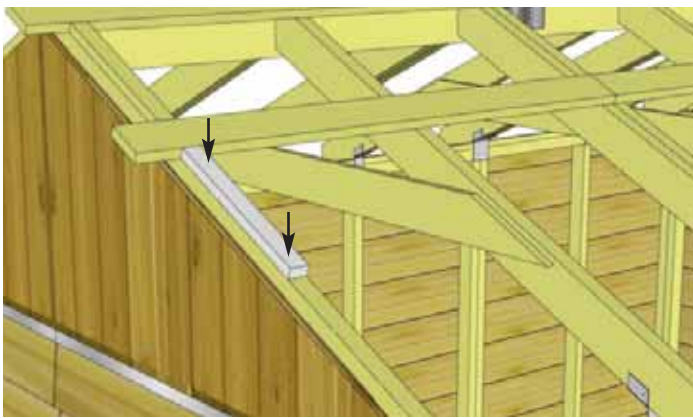

43. Locate another pair of **Batten Spacers** and position flush with second row of Battens. Attach Batten Spacers to outside Rafter with **2 - 1 1/4" screws** per **Spacer**. Locate 2 more **Outside Roof Battens** and 1 **Inside Roof Batten**, position Battens flush to **Batten Spacers**. Attach each **Batten** to Rafters with **3 - 1 1/4" screws** (9 total).

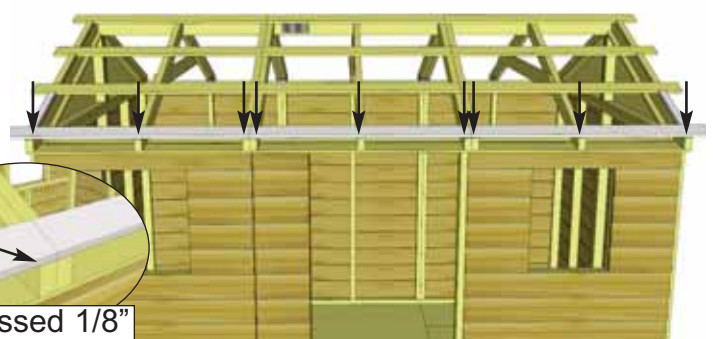
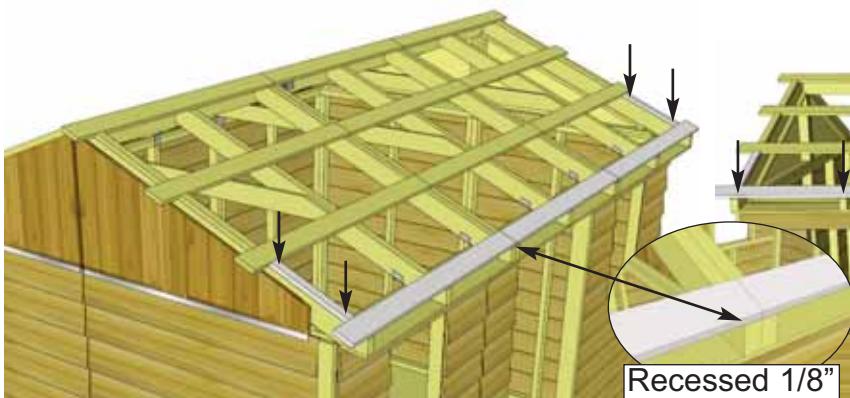

44. Locate another pair of **Batten Spacers** and position flush with third row of Battens. Attach Batten Spacers to outside Rafter with **2 - 1 1/4" screws** per **Spacer**. Locate 2 more **Outside Roof Battens** and 1 more **Inside Roof Batten**. Position Battens flush to **Batten Spacers**, **Battens** should be recessed $\frac{1}{8}$ " from end of Rafters. Attach each **Battens** to Rafters with **3 - 1 1/4" screws** (9 total).

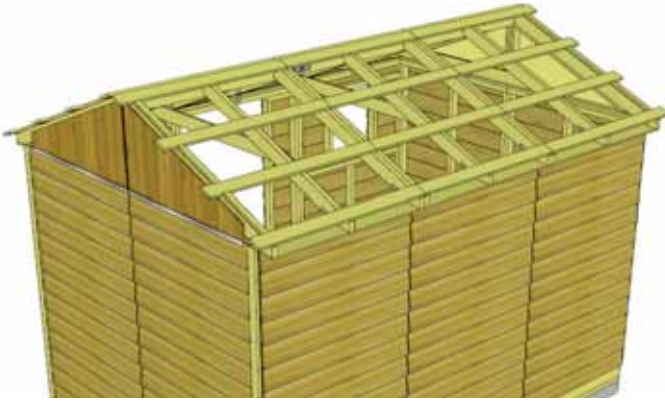

45. Repeat **Steps 49 - 44** to complete Batten Section on opposite side of roof with remaining **Battens** and **Batten Spacers**.

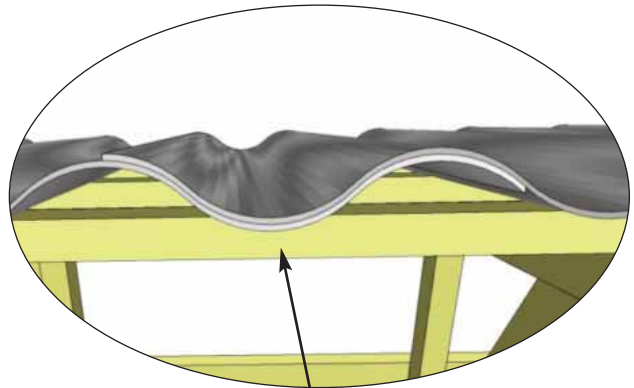
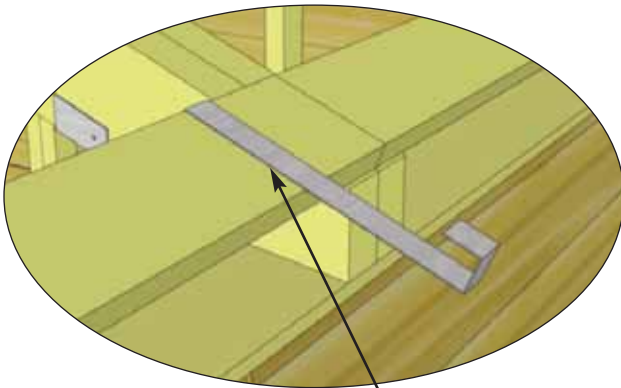

46. Locate 4 **Metal Roof Panels** and 4 **Metal Roof Hangars**. To temporarily hold the **Metal Roof Panels** in place, hook a **Metal Roof Hangar** onto the lowest Batten, approximatley where the center of the panels will be. Place first **Metal Roof Panel** on Battens and into Hangar. Do not fasten panels down until **Step 51**. Place remaining 3 panels and hangars on the same way. Metal Roof Panels will overlap eachother.

Parts (Step 46)
Metal Roof Panels
 (39" wide x 61" long) x 4
 Hardware (Step 46)
Y38 - Metal Roof Hangars
 x 4 total

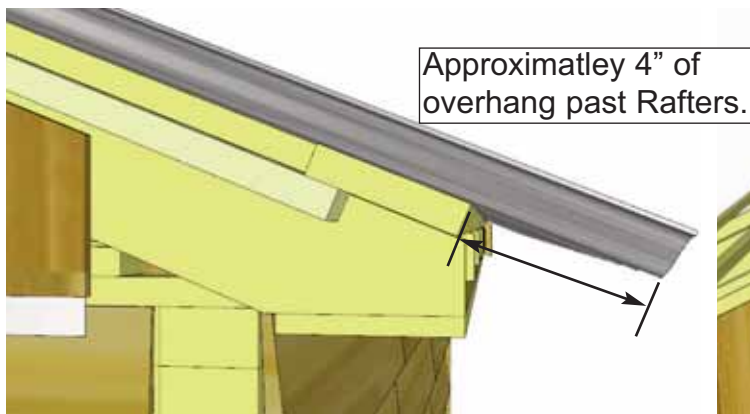

47. Overhang the **Metal Roof Panels** past the **Battens** on front and rear of shed by approximatley 1". Adjust panels side-to-side to achieve desired width. Overall width past the **Battens** can vary from 1" - 3" depending on your preference. The overhang over the side of the shed will be set by the **Metal Roof Hangars**, but should be approximatley 4" on side of shed.

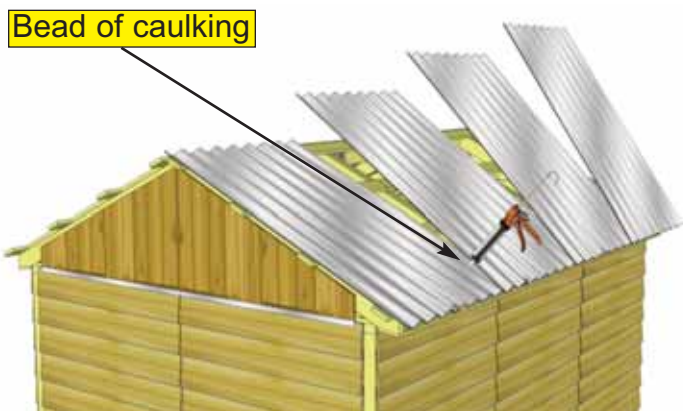

48. Once the Metal Roof Panels are spaced correctly from side-to-side and top-to-bottom, lift 3 panels up and run a bead of caulking down the overlapping seams of each panel to seal the joints. Place panels down one by one once seam is caulked. You will likely need assistance from a helper for this step. Caulk each seam.

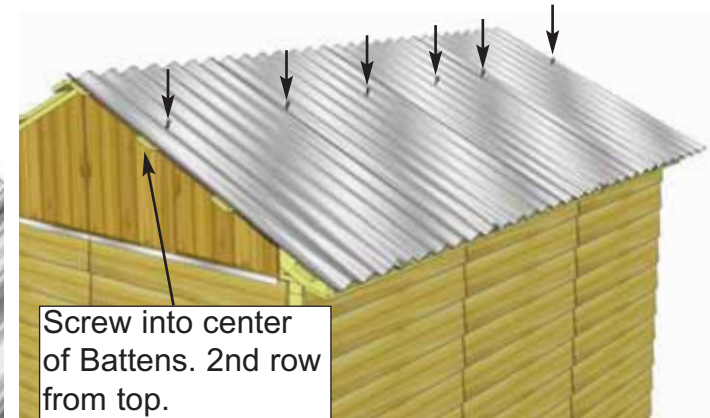
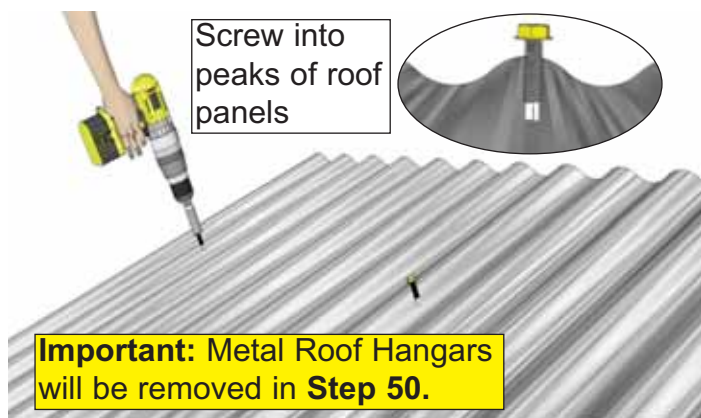

49. Using **6 - 2" Metal Screws** and **1/4" Nut Driver** (included), partially secure **Metal Roof Panels** to 2nd row of **Battens** from top. Only fasten screws halfway so that **Metal Roof Hangars** can be removed in **Step 50**. Metal screw is self-tapping, screw into center of Battens

Hardware (Step 49)
2" - Metal Roof Screws
 x 6 total

Important: Remove Metal Roof Hangars

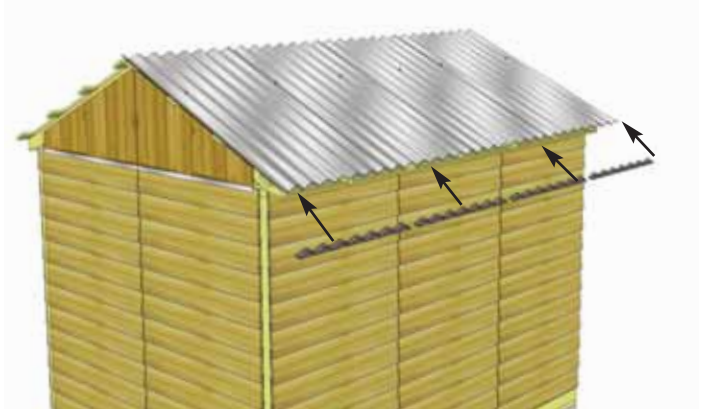
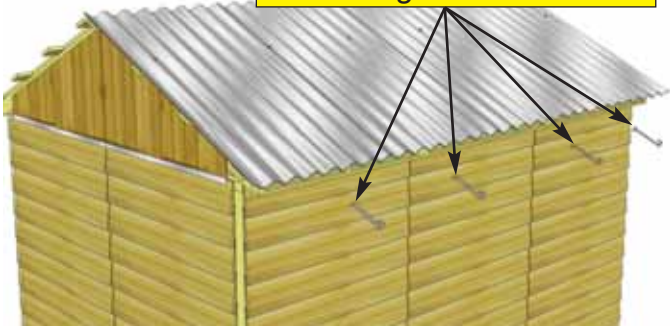

50. Before fully fastening **Metal Roof Panels** down, remove the **Metal Roof Hangars** and insert **Foam Enclosures** between **Metal Roof Panels** and **Battens** at the bottom of the roof. Enclosures will prevent moisture and unwanted bugs, etc from entering your shed through here.

Parts (Step 50)
Foam Enclosures
(Several Pcs)

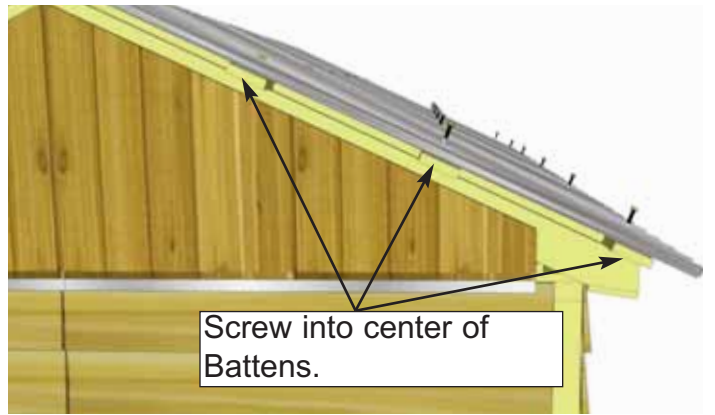
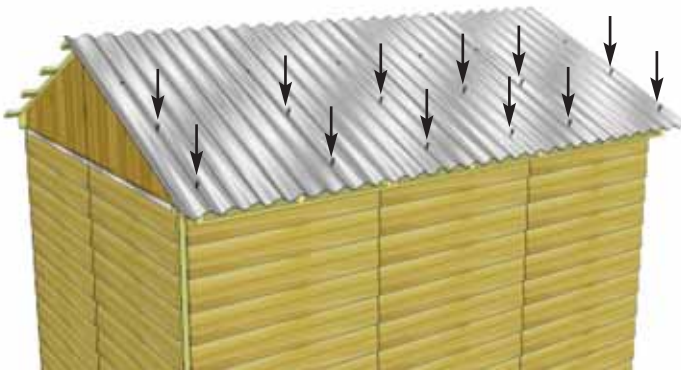

51. Using **12 - 2" Metal Screws** and 1/4" Nut Driver, secure **Metal Roof Panels** down to lower 2 rows of **Battens**. Leave the top row unsecured for now to secure Ridge Cap later in **Step 54**. Tighten screws in middle row that were partially secured in **Step 54**. Do not overtighten!

Hardware (Step 51)
2" - Metal Roof Screws
x 12 total



52. Repeat Steps 46 - 51 to complete opposite side of Metal Roof.



53. Locate remaining **Foam Enclosures**. Place **Foam Enclosures** at the top of roof panels. **Foam Enclosures** prevent moisture from coming in through the top of your shed.

Parts (Step 53)
Foam Enclosures
 (Several Pcs)



54. Place 3 **Metal Ridge Caps** onto apex of roof. Evenly space from front to back of your shed, Metal Ridge Caps will overlap each other. Overhang the cap approximately 1" - 2" past each end. When **Metal Ridge Caps** are correctly positioned, secure with **12 - 2" Metal Ridge Screws** (6 per side). Screw into center of final **Batten**. Do not overtighten!

Parts (Step 54)
Metal Ridge Caps
 (60" long) x 3

Hardware (Step 54)
2" - Metal Ridge Screws
 x 12 total

D. Miscellaneous Section

Important- Illustrations show shed with Cedar and Metal Roof Panels and assembly is interchangeable.

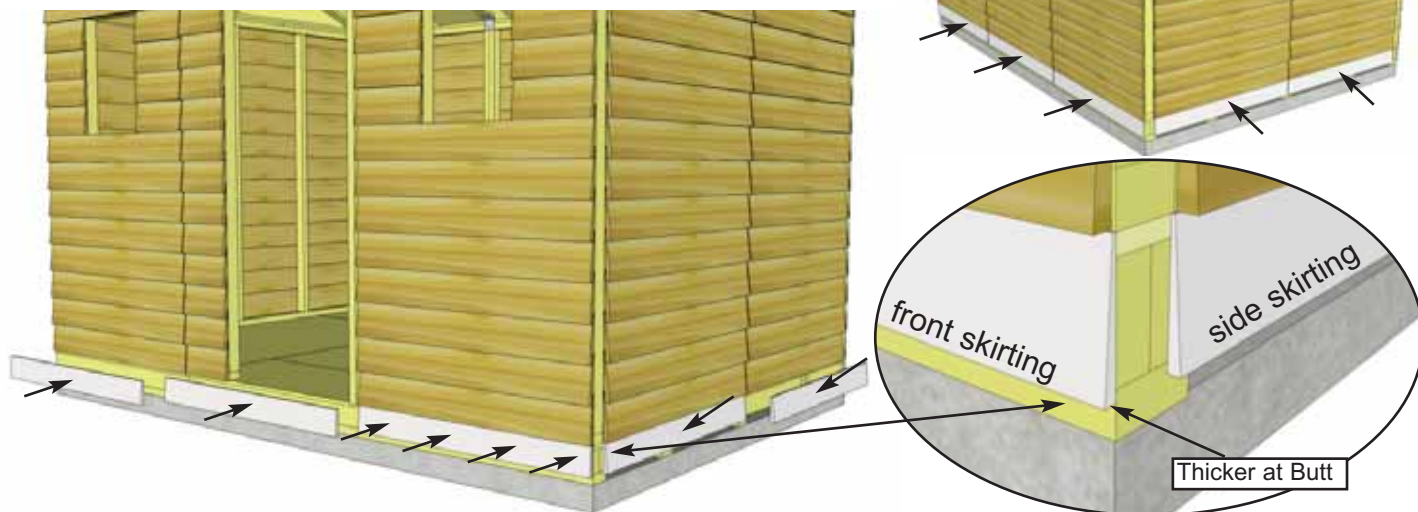

55. Attach **Bottom Skirting - Bevel** around the base of the shed. Bevel is thicker at butt and thinner at top of board. Skirting will hide floor framing. Gaps on side will be covered by Wide Trim pieces later. Start with Front and Rear Skirting pieces first and attach with **4 - 1 1/2" Finishing Nails** per piece.

<u>Parts</u>
Bottom Skirting - Bevel (3/4" x 4 1/2" x 45 1/4") x 10
<u>Hardware</u>
N1 - 1 1/2" Finishing Nails x 40 total

Expert Advice: When installing trim, sort pieces according to color and pieces that are most pleasing to the eye. Start with least visible side of shed and use the least desirable pieces first. Install trim to most visible side of shed as your skill installing trim improves.

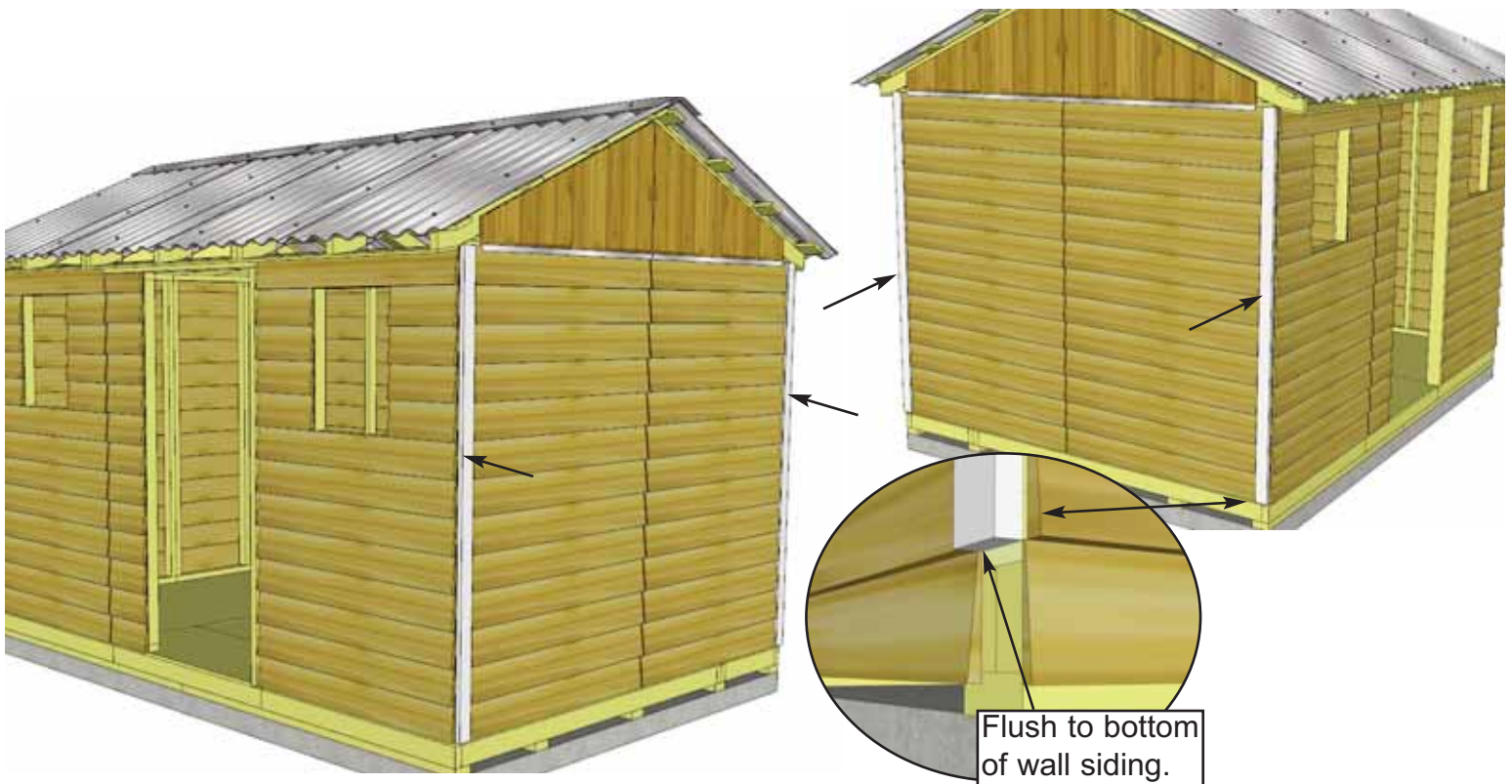

56. Attach **Filler Trim** to each corner side wall. Align Filler Trim so it sits flush with the bottom of the last piece of Wall siding. Attach with **8 - 1 1/2" Finishing Nails** per piece.

Parts
Filler Trim
 (7/8" x 2 1/2" x 75") x 4

Hardware
N1 - 1 1/2" Finishing Nails
 x 32 total



57. Trim out Front Window Walls and Rear Solid Walls by attaching **Top Wall Trim**. Position with thick end of Bevel downward at top of wall, tight against Soffits. Attach with **4 - 1 1/2" Finishing Nails** per piece.

Parts
Top Wall Trim (Bevel)
 (3/4" x 1 1/2" x 45 1/4") x 5

Hardware
N1 - 1 1/2" Finishing Nails x 20 total

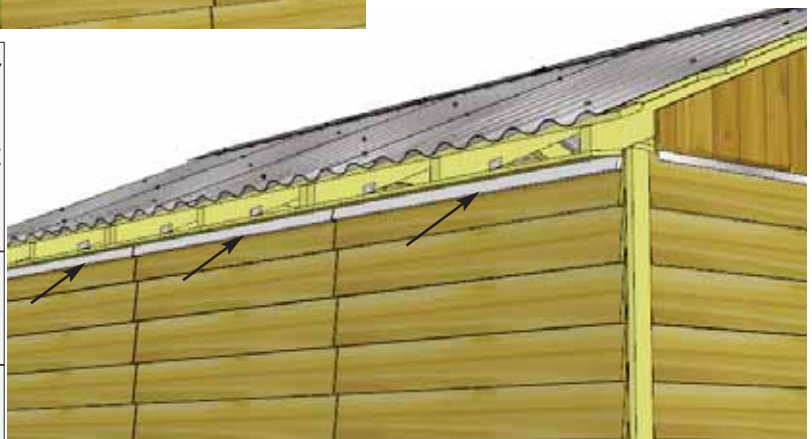



58. Attach **Horizontal Gable Trims** to both sides of shed (2 per side). Position over gable and wall seam with thick end of Bevel downward. Use **4 - 1 1/2" Finishing Nails** to secure each piece.

Parts

Horizontal Gable Trims - Bevel
 (3/4" x 4 1/2" x 45 1/4") x 4

Hardware

N1 - 1 1/2" Finishing Nails x 16 total

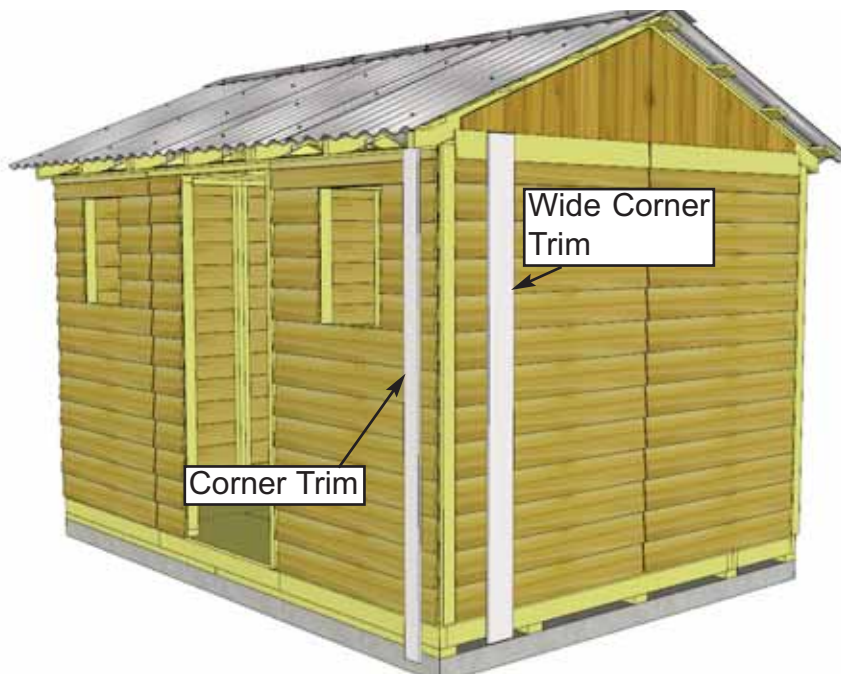

59. To trim out corners, start with a **Corner Trim**, align tight underneath Soffit and Rafter. Align **Wide Corner Trim** with bottom of Corner Trim. Corner Trim will cap the Wide Corner Trim. Do a dry run in each corner before attaching to confirm positioning. Use **8 - 1 1/2" Finishing Nails** per piece to secure. Complete other front corner the same.

Parts (Steps 59 - 60)	Hardware (Steps 59 - 60)
Corner Trim (1/2" x 3 1/2" x 79") x 4	N1 - 1 1/2" Finishing Nails x 64 total
Wide Corner Trim (1/2" x 5 1/2" x 82") x 4	



60. Trim out rear corners with remaining pieces of **Corner Trim** and **Wide Corner Trim**. Align and attach with **8 - 1 1/2" Finishing Nails** per piece as per **Step 59**.

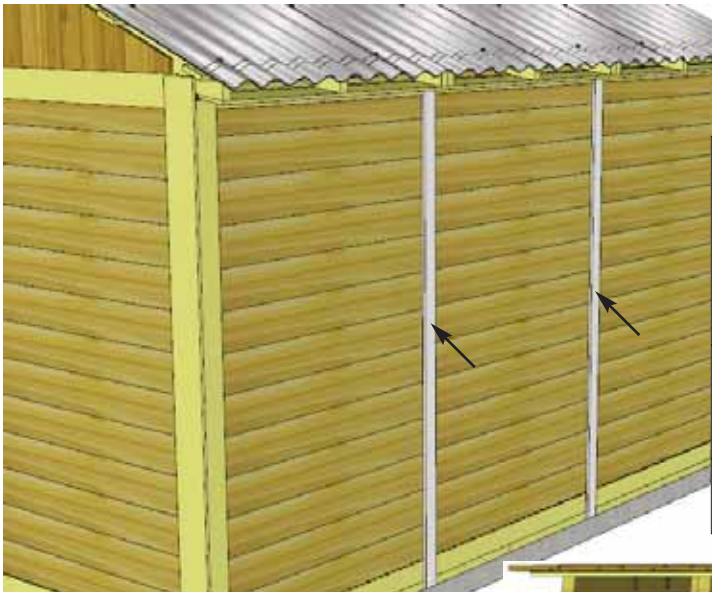

61. Attach **Rear Wall Narrow Trim** where wall panels come together and leave a seam. Position trim equally on wall seam and tight underneath Soffit and Rafter. Use **8 - 1 1/2" Finishing Nails** per piece to secure.

<u>Parts</u>
Rear Wall Narrow Trim (1/2" x 2 1/2" x 79") x 2
<u>Hardware</u>
N1 - 1 1/2" Finishing Nails x 16 total

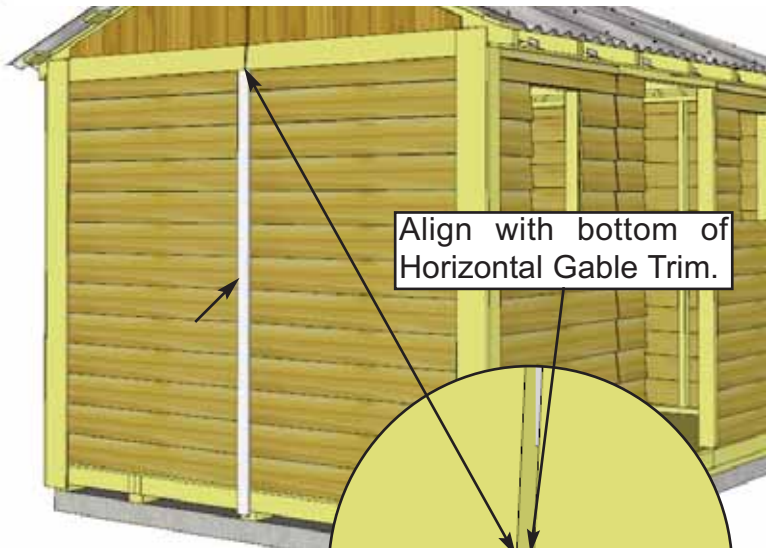
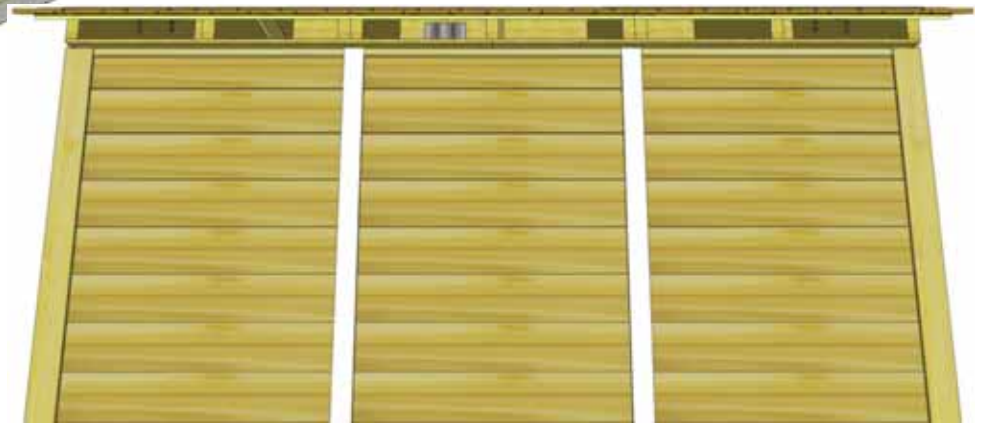

62. Attach both **Side Wall Narrow Trims** where wall seams come together on sides. Position trim equally on wall seam and flush with the bottom of the Horizontal Gable Trim. Use **8 - 1 1/2" Finishing Nails** per piece to secure.

<u>Parts</u>
Side Wall Narrow Trim (1/2" x 2 1/2" x 77 1/2") x 2
<u>Hardware</u>
N1 - 1 1/2" Finishing Nails x 16 total

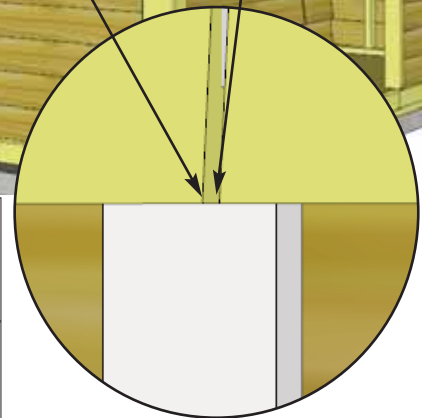



Facia/Roof Nailing Strips
(4 @
3/4" x 2 1/2" x 48"



63. Attach **Facia/Roof Nailing Strips** (3/4" x 2 1/2" x 51") to the underside edge of roof battens with 4 - 1 1/4" Screws per piece. Nailing Strip will make it easier to attach Front and Rear Facia in **Step 64**. Complete attaching strips on left and right sides (2 per side, 4 pieces total).

<u>Parts</u> Facia Nailing Strips (3/4" x 2 1/2" x 51") x 4
<u>Hardware</u> S2 - 1 1/4" Screws x 16 total

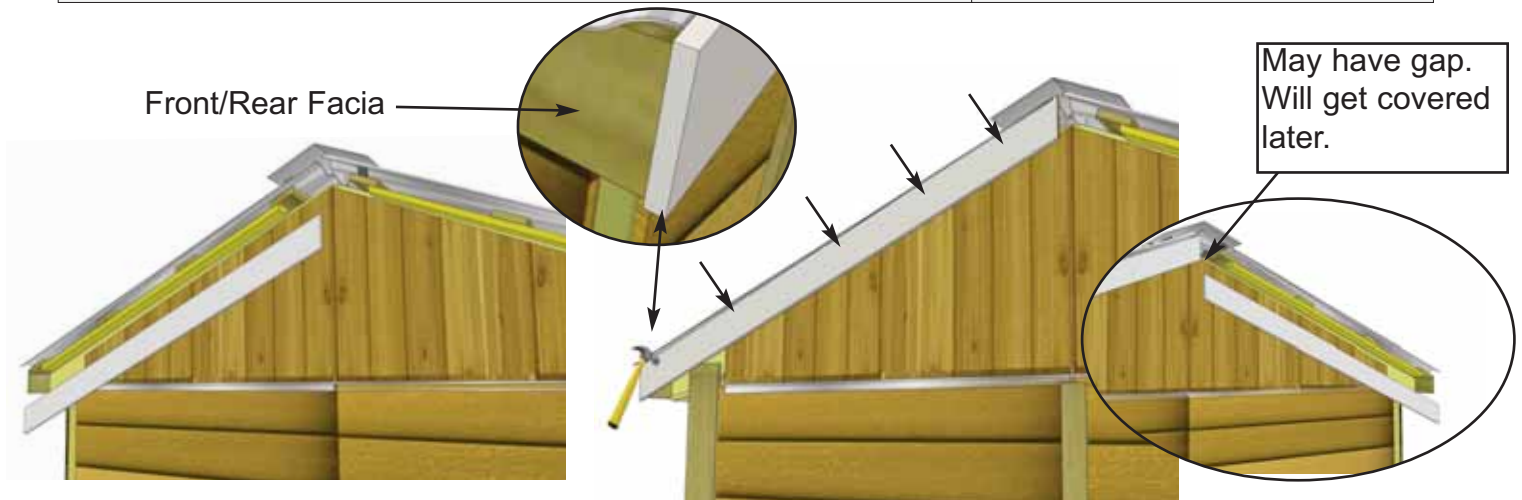

Front/Rear Facia

May have gap.
Will get covered
later.

64. Attach **Side Facia** to nailing strips (2 pieces per side). Secure with 4 - 1 1/2" **Finishing Nails** per piece, end of Facia should be aligned flush with end of Rafter. Gap where Facia boards come together at peak will be covered in **Step 66**.

<u>Parts</u> Side Facia - Angle Cut Ends (3/4" x 3 1/2" x 58") x 4
<u>Hardware</u> N1-1 1/2" Finishing Nails x 16 total

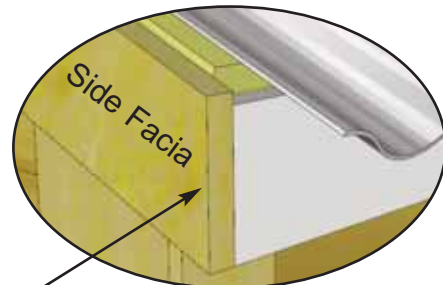

Side Facia caps Front/Rear Facia

65. Attach **Front and Rear Facia** to rafter ends (2 pieces per side). Secure with 8 - 1 1/2" **Finishing Nails** per piece, ensure nails connect with ends of rafters behind Facia. Gaps between Facia pieces will be covered by Detail plates in **Step 67**.

<u>Parts</u> Front & Rear Facia (3/4" x 3 1/2" x 71 3/4") x 4
<u>Hardware</u> N1-1 1/2" Finishing Nails x 32 total

Pentagon Facia Plate



66. Attach **Pentagon Facia Plate** where End Facia meets at the peak. Use 4 - 1 1/2" finishing nails per piece to secure.

Parts
Pentagon Facia Plates
 (1/2" x 3 1/2" x 8") x 2

Hardware
N1 - 1 1/2" Finishing Nails x 8 total

Facia Detail Plate



67. Attach **Facia Detail Plate** to side facia where they meet in the middle. Use 4 - 1 1/2" finishing nails per piece to secure. Complete both sides. Attach **Horizontal Gable Detail Plates** to cover seams where Horizontal Gable Trims meet. Secure with 4 - 1 1/2" Finishing Nails per piece.

Parts
Facia Detail Plates
 (1/2" x 3 1/2" x 8") x 2
Horizontal Gable Plates
 (1/2" x 4 1/2" x 8") x 2

Hardware
N1 - 1 1/2" Finishing Nails
 x 16 total

Horizontal Gable Detail Plate



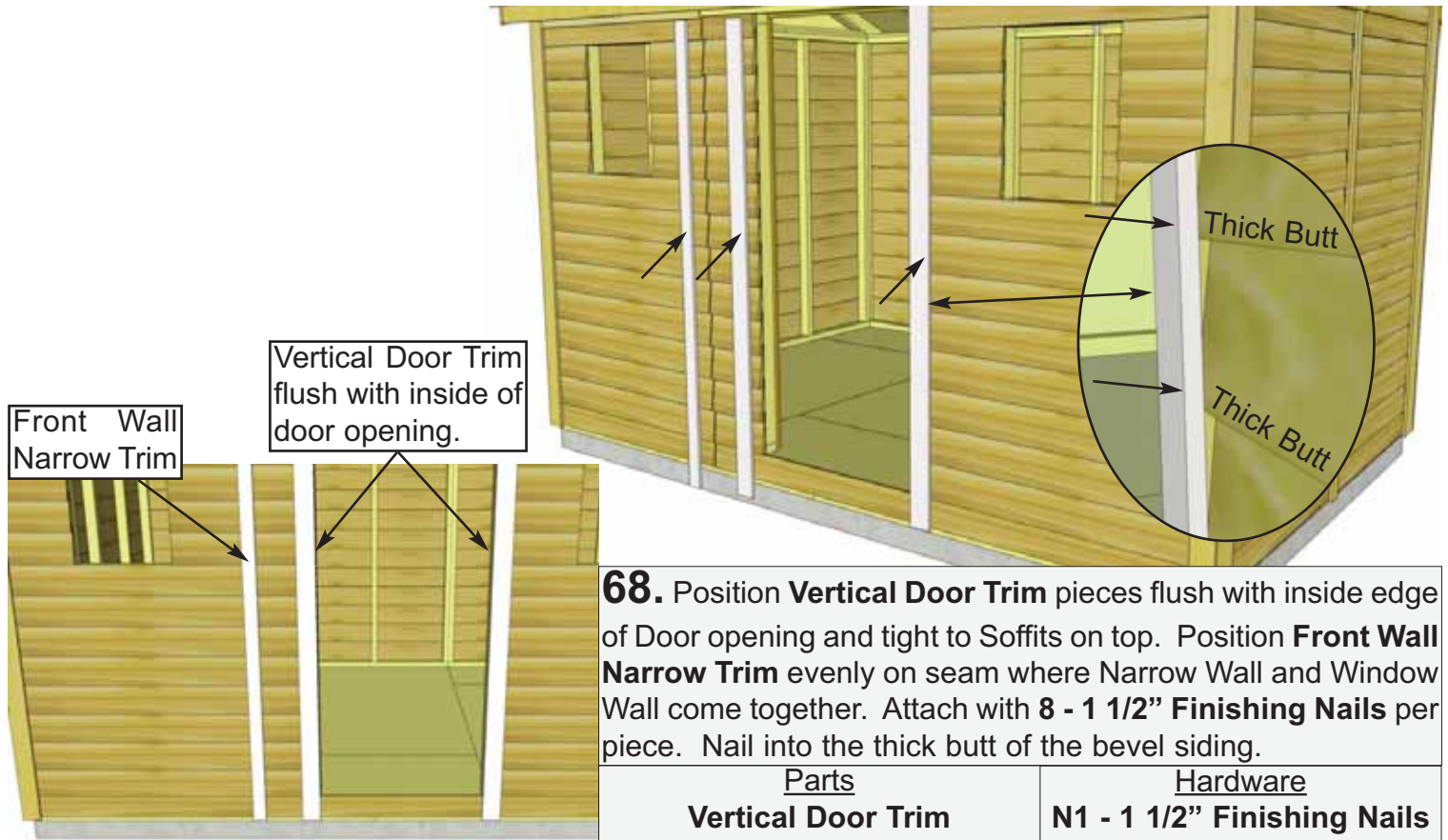

68. Position **Vertical Door Trim** pieces flush with inside edge of Door opening and tight to Soffits on top. Position **Front Wall Narrow Trim** evenly on seam where Narrow Wall and Window Wall come together. Attach with **8 - 1 1/2" Finishing Nails** per piece. Nail into the thick butt of the bevel siding.

Parts	Hardware
Vertical Door Trim (1/2" x 3 1/2" x 79") x 2	N1 - 1 1/2" Finishing Nails x 24 total
Front Wall Narrow Trim (1/2" x 2 1/2" x 79") x 1	



69. Attach **Horizontal Door Trim** with **4 - 1 1/2" Finishing Nails** and **Horizontal Narrow Wall Trim** with **2 - 1 1/2" Finishing Nails** to cover Door Header.

Parts
Horizontal Door Trim (1/2" x 1 1/4" x 32") x 1
Horizontal Narrow Wall Trim (1/2" x 1 1/4" x 7") x 1
Hardware
N1 - 1 1/2" Finishing Nails x 6 total



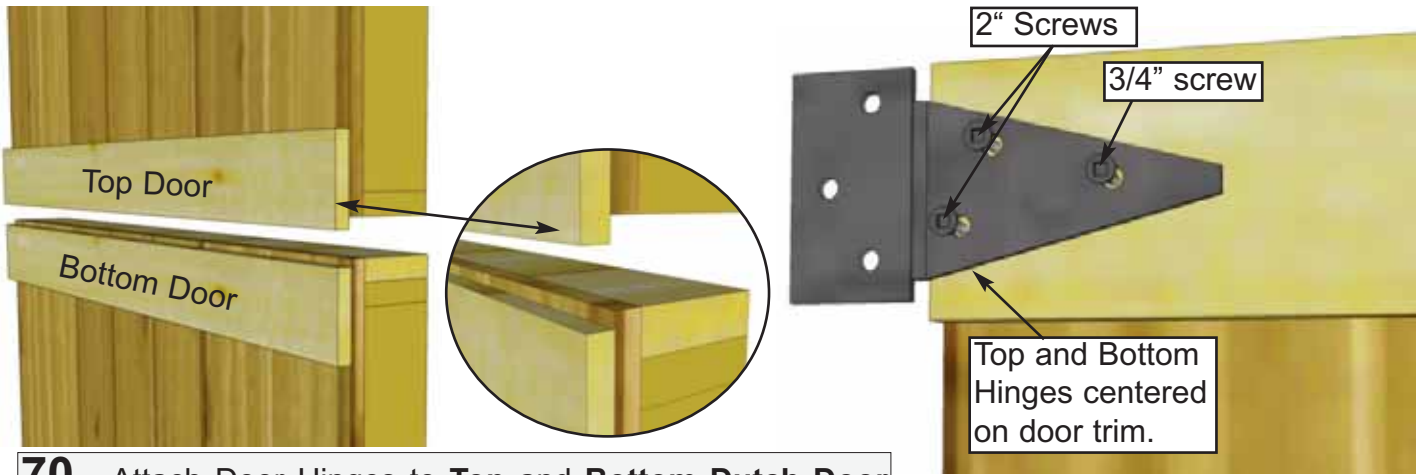

70. Attach Door Hinges to **Top** and **Bottom Dutch Door** sections. Top Door has trim overhanging door at bottom while bottom door has trim recessed slightly. Hinges should be centered on door trim with barrel nudged to end of trim. Use **2" & 3/4" Black Headed Screws** as shown above.

Parts (Steps 67 - 69)

Dutch Door - Top
(31 1/2" x 30") x 1
Dutch Door - Bottom
(31 1/2" x 42") x 1

Hardware (Steps 67 - 69)

Y1 - Tee Hinges
x 4 total
SB1 - 3/4" Black Screws
x 4 total
SB2 - 2" Black Screws
x 20 total

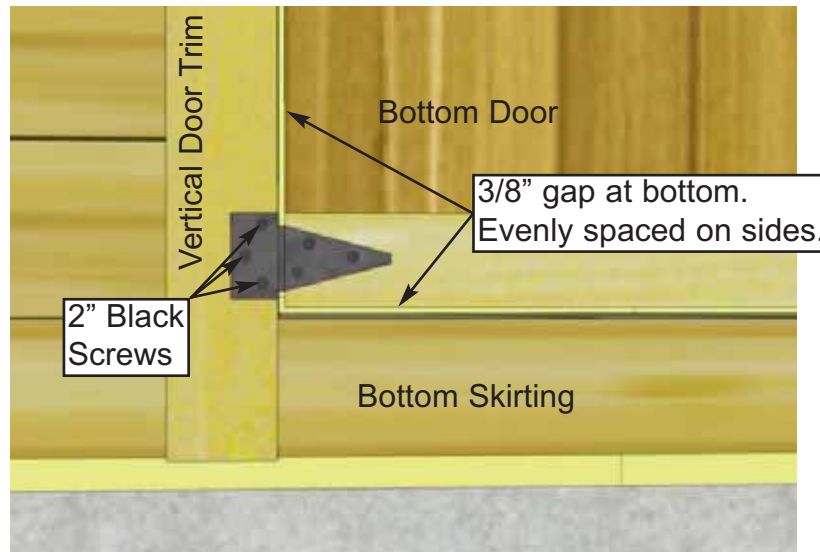
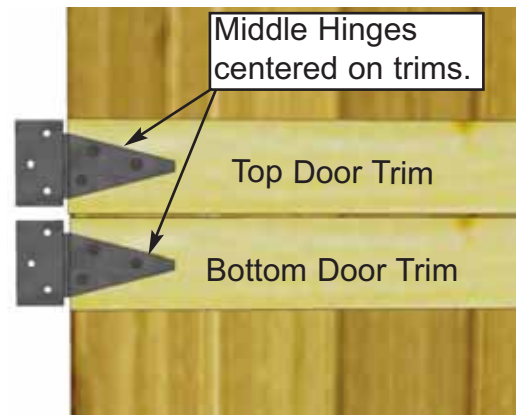

71. Place Bottom Dutch Door panel into position. Gap 3/8" on bottom, evenly space on sides, and attach hinge to doorway seam trim with **2" Black Headed Screws**. Use shim to help keep the door evenly spaced on bottom. One of the extra roof shingles (see parts list) can be used.

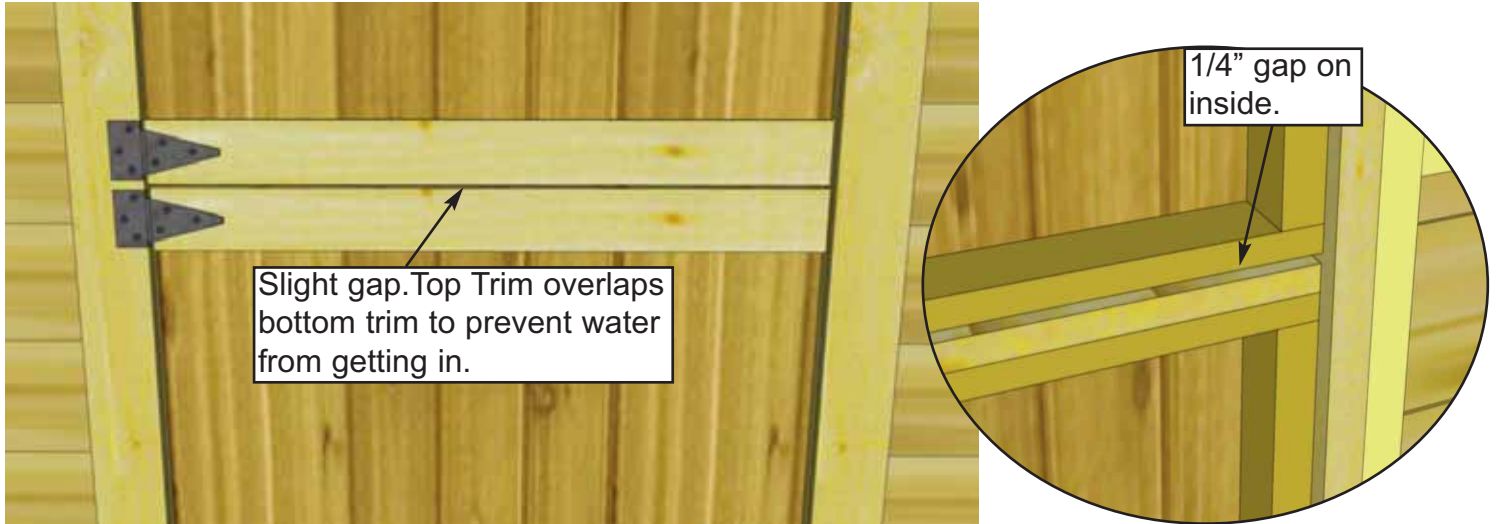

72. Place the Top Dutch Door Panel into place and gap top and bottom trims on the outside about 1/8" apart. On the inside, horizontal door frames should be about 1/4" apart. Use a shim once again to help you. Attach hinges to trim with **2" Black Headed Screws** provided.

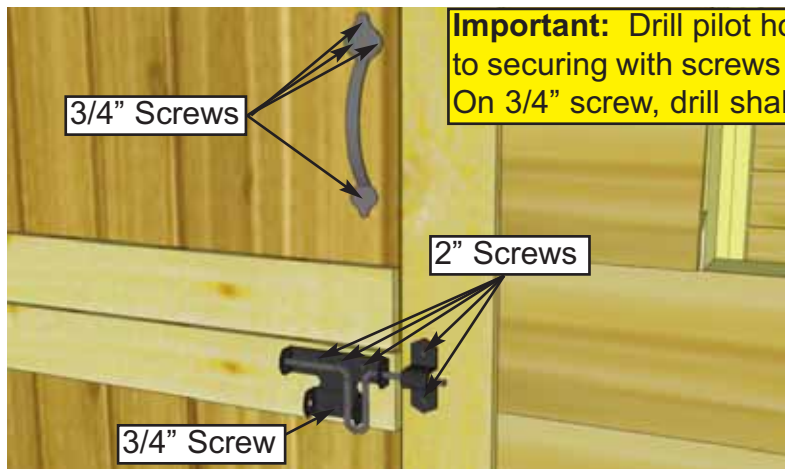

Important: Drill pilot holes with 1/8" drill bit prior to securing with screws to prevent wood splitting. On 3/4" screw, drill shallow pilot hole only.

73. Attach **Door Handle** and **Exterior Black Drop Latch** to door. Handle is positioned on top door, Drop Latch on bottom door. Attach Black Drop Latch as illustrated above with **2" & 3/4" Black Screws**. Note how female part of Drop Latch is positioned higher than male. Do a dry run first to position Drop Latch correctly. Attach Handle with 2" Screws, ensure screws connect with inner door stud.

Hardware
Y3 - Door Handle
 x 1 total
Y4 - Drop Latch
 x 1 total
SB1 - 3/4" Black Screws
 x 5 total
SB2 - 2" Black Screws
 x 5 total

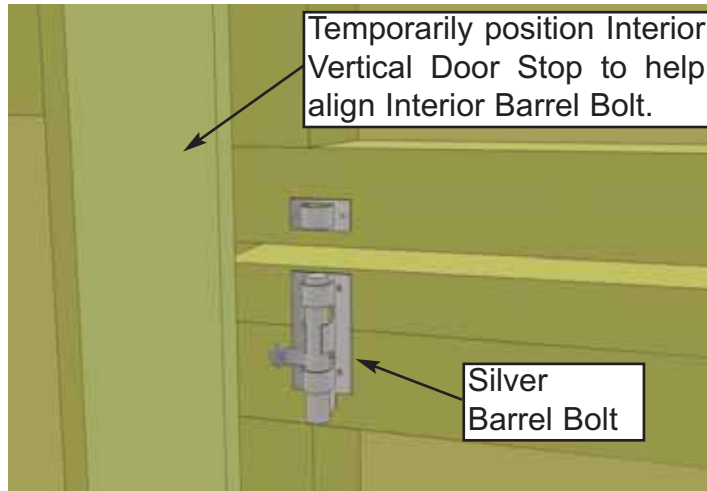

74. Attach Interior **Silver Barrel Bolt** to inside of door as illustrated above. Use **3/4" Silver Screws** to secure. Refer to **Step 75** to allow for adequate clearance.

Hardware
Y5 - Silver Barrel Bolt x 1 total
SS2 - 3/4" Silver Screws x 6 total

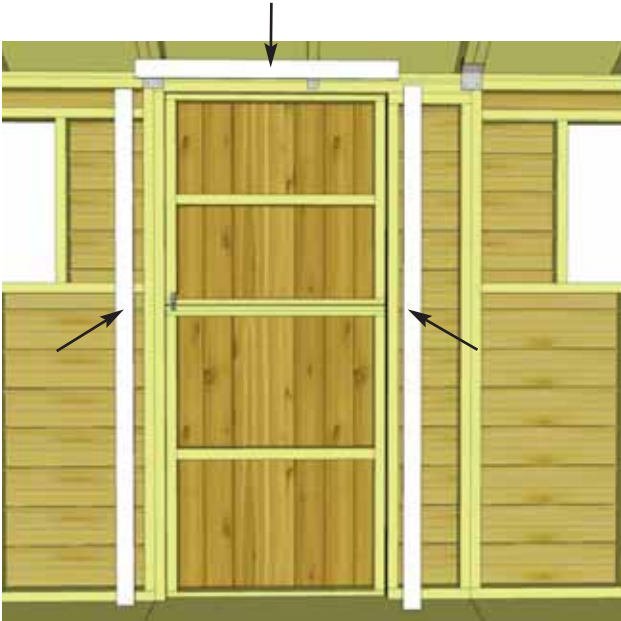

75. Attach Interior Door Stops to door framing (Jambs and Header). Start with **Vertical Door Stops**. Stops should overlap doorway by 1/2". Use **4 - 1 1/4" Screws** to secure each piece. Attach **Horizontal Door Stop** next using **3 - 1 1/4" Screws**.

Parts
Vertical Door Stops (1/2" x 2 1/2" x 72") x 2
Horizontal Door Stop (1/2" x 2 1/2" x 36") x 1

Hardware
S2 - 1 1/4" Screws x 11 total



76. To reduce possible water from penetrating into the window cavity, caulk gap on both sides of window opening prior to installing **Window Insert**. Position insert in cavity and screw with **6 - 1 1/4" Screws**. On sides, make sure to screw insert into the thick butt of the siding only.

<u>Parts</u>
Window Inserts x 2
<u>Hardware</u>
S2 - 1 1/4" Screws x 12 total

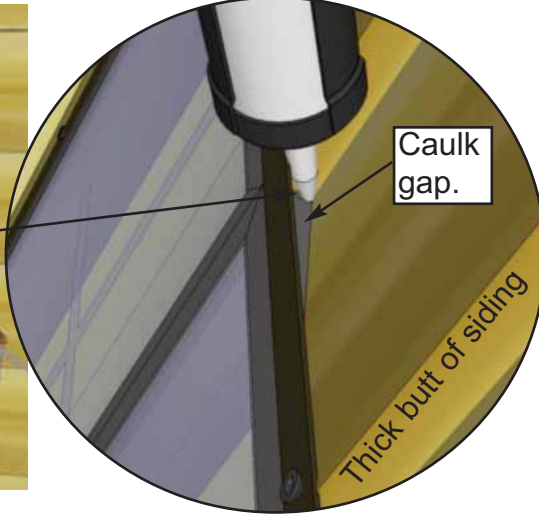
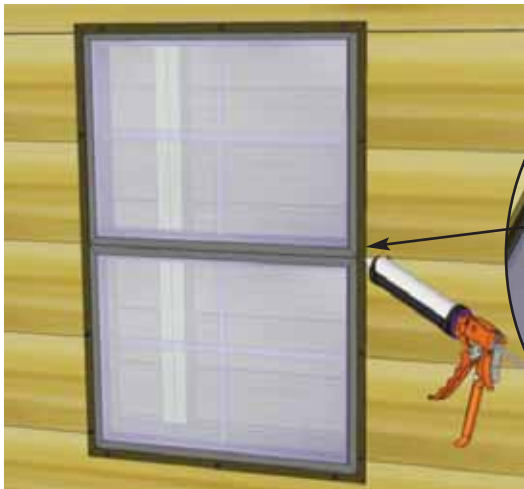

77. Once Insert is attached, caulk the "triangular gap" between the Insert's outside flange and the siding. Also put a bead of caulking horizontally at top of window where the flange and siding meet. This additional caulking will also will reduce the chances of moisture entering into your shed.

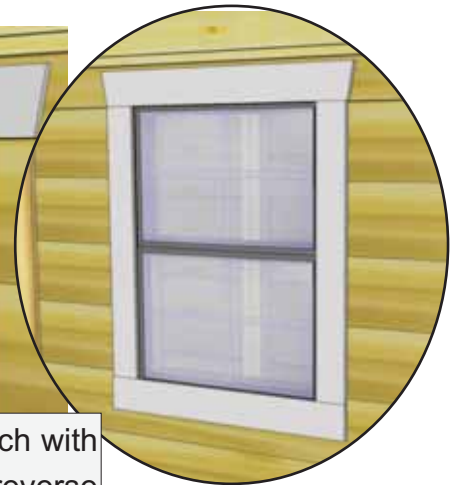
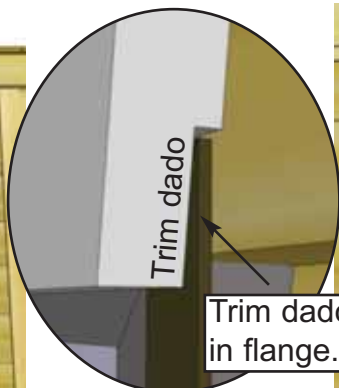

78. Position **Window Trim** around window doing a dry run first and attach with **4 - 1 1/2" Finishing Nails** per piece. Window trim has a small dado on reverse face. Outside flange of window will roughly sit in the dado to give a better fit.

<u>Parts</u>	<u>Hardware</u>
Window Trim Package x 2 (Top - 24 1/16" Long - <i>Angle Cut Ends</i>) x 1 (Sides & Bottom - 23" Long) x 3	N1 - 1 1/2" Finishing Nails x 32 total

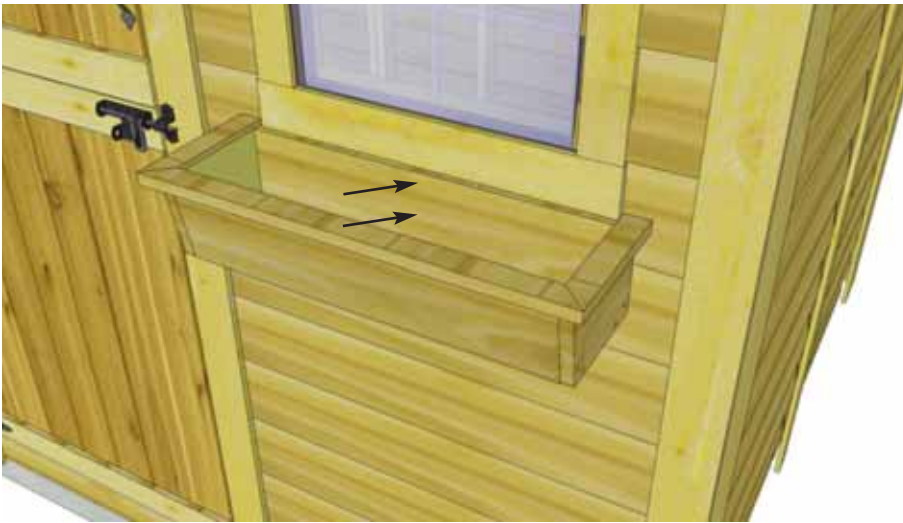

79. Assemble **Flower Box** with Assembly Instructions included on Page 44. Position completed Flower Box below bottom of window trim and secure with **2 - 2" Screws** per box. Screw from inside of box into the center Window Wall stud. Attach second screw 2" underneath first screw and once again into the wall stud. Install Flower Box Kits underneath each window.

<p><u>Parts</u> Flower Box Kits x 2 <u>Hardware</u> S3 - 2" Screws x 4 total</p>
--

Outdoor Living Today Flower Box Assembly Instructions

Parts Lists:

A - Base, Rear & Front Box Frames	(3pcs)	3/4" x 5 1/2" x 23"
B - End Cap Frames	(2pcs)	3/4" x 5 1/2" x 7" / 8"
C - Front Trim	(1 pc)	3/4" x 1 1/2" x 26"
D - Side Trims	(2 pc)	3/4" x 1 1/2" x 8 3/4"
E - Brackets	(2 pc)	1 1/2" x 5 1/2" x 5 1/2"
F - 1 1/4" Screws		
G - 1 1/4" Nails		

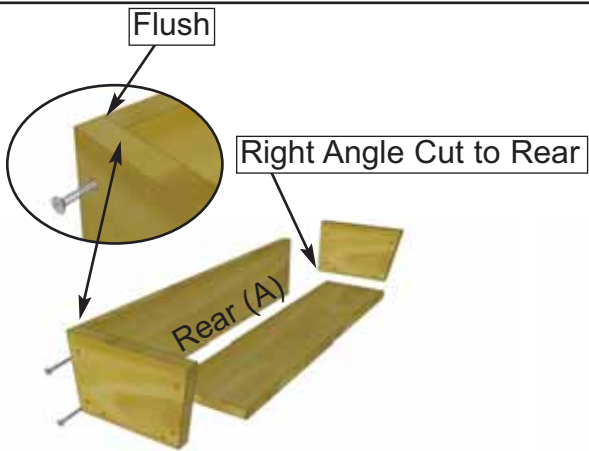
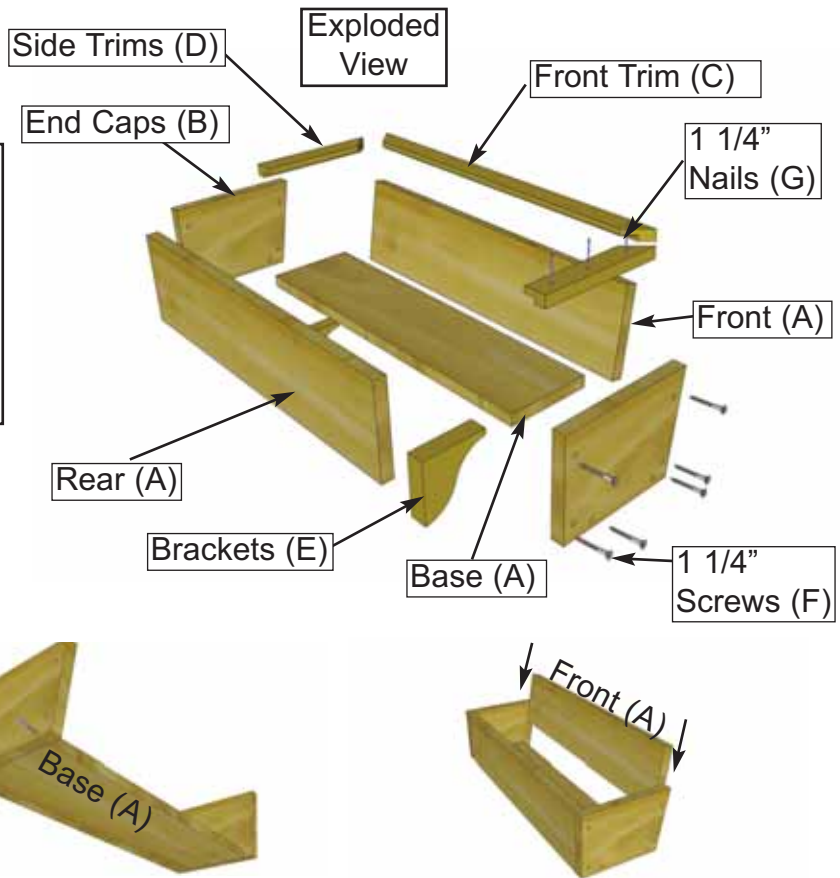

1. On a table position Rear Box and End Cap Frames together so flush at top. Fasten together with 2 - 1 1/4" screws. Place Base Frame tight against Rear and End Cap and flush at bottom. Secure with 2 - 1 1/4" screws. Complete attachment of remaining End Cap Frame. Slide Front Frame between End Caps.

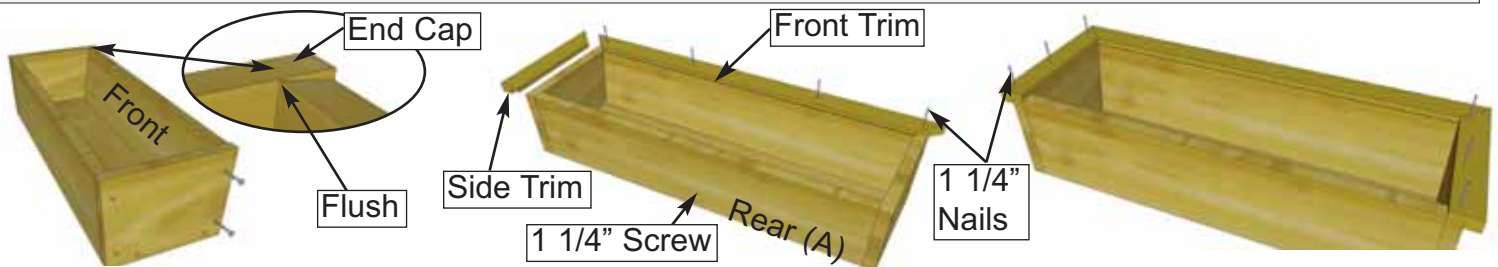

2. Position Front Frame Piece flush with End Cap. Attach both ends with 2 - 1 1/4" screws. Pilot hole Rear Box Frame near bottom center and secure to Base edge with 1 - 1 1/4" screw. Evenly position Front Trim (mitre cut on end and dado cut on inside bottom) tight against front frame and nail down with 4 - 1 1/4" nails. Position Side Trims as per Front and secure with 3 - 1 1/4" nails per side.

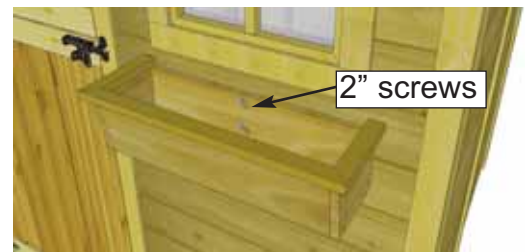
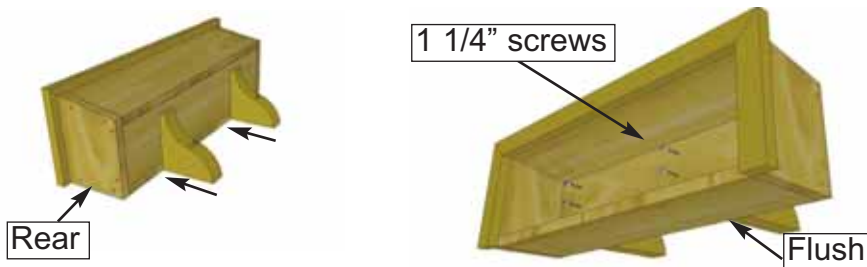

3. On a flat surface, flip Flower Box on it's rear face. Evenly space Brackets and secure through Base Frame and into the Brackets with 2 - 1 1/4" screws per Bracket. Position completed Flower Box beneath window trim and screw from inside of box into the center wall stud with 2 - 2" screws. (2" screws supplied with Base Kit.)



Congratulations on assembling your 12x8 Cabana!

Note: Our Sheds are shipped as unfinished products. If exposed to the elements, the western red cedar lumber will weather to a silvery-gray color. If you prefer to keep the cedar lumber looking closer to the original color, we suggest that you treat the wood with a good oil base wood stain. You may also wish to paint your new shed rather than stain it. In both cases we recommend that you consult with a paint and stain dealer in your area for their recommendations.

We hope your experience assembling your 12x8 Cabana Garden Shed has been both positive and rewarding.



We value your feedback and would like to hear back from you on how well we are doing in the following areas:

1. Customer Service
2. On Time Shipping
3. Motor Freight Delivery
4. Quality of Materials
5. Assembly Manual
6. Overall Satisfaction.

Please call, write or email us at:

Outdoor Living Today

Canadian Address
9393 287th Street
Maple Ridge, British Columbia
Canada V2W 1L1

United States Address
P.O. Box 96
Sumas, Washington
USA 98295



The materials contained in this Assembly Manual may be downloaded or copied provided that ALL copies retain the copyright and any other proprietary notices contained on the materials. No material may be modified, edited or taken out of context such that its use creates a false or misleading statement or impression as to the positions, statements or actions.